



HIRSCHMANN

A **BELDEN** BRAND

User Manual

Redundancy Configuration

Industrial ETHERNET (Gigabit-)Switch

RS20/RS30/RS40, MS20/MS30, OCTOPUS, PowerMICE,

RSR20/RSR30, MACH 100, MACH 1000, MACH 4000

The naming of copyrighted trademarks in this manual, even when not specially indicated, should not be taken to mean that these names may be considered as free in the sense of the trademark and tradename protection law and hence that they may be freely used by anyone.

© 2013 Hirschmann Automation and Control GmbH

Manuals and software are protected by copyright. All rights reserved. The copying, reproduction, translation, conversion into any electronic medium or machine scannable form is not permitted, either in whole or in part. An exception is the preparation of a backup copy of the software for your own use. For devices with embedded software, the end-user license agreement on the enclosed CD/DVD applies.

The performance features described here are binding only if they have been expressly agreed when the contract was made. This document was produced by Hirschmann Automation and Control GmbH according to the best of the company's knowledge. Hirschmann reserves the right to change the contents of this document without prior notice. Hirschmann can give no guarantee in respect of the correctness or accuracy of the information in this document.

Hirschmann can accept no responsibility for damages, resulting from the use of the network components or the associated operating software. In addition, we refer to the conditions of use specified in the license contract.

You can get the latest version of this manual on the Internet at the Hirschmann product site (www.hirschmann.com).

Printed in Germany
Hirschmann Automation and Control GmbH
Stuttgarter Str. 45-51
72654 Neckartenzlingen
Germany
Tel.: +49 1805 141538

Contents

	About this Manual	5
	Key	7
1	Introduction	9
1.1	Overview of Redundancy Topologies	10
1.2	Overview of Redundancy Protocols	12
2	Link Aggregation	15
2.1	Example of link aggregation	16
2.1.1	Creating and configuring the link aggregation	17
2.2	HIPER-Ring and Link Aggregation	22
3	Ring Redundancy	25
3.1	Example of a HIPER-Ring	28
3.1.1	Setting up and configuring the HIPER-Ring	30
3.2	Example of a MRP-Ring	34
3.3	Example of a Fast HIPER-Ring	40
4	Multiple Rings	45
4.1	Sub-Ring	46
4.1.1	Sub-Ring description	46
4.1.2	Sub-Ring example	50
4.1.3	Sub-Ring example configuration	53
5	Ring/Network Coupling	59
5.1	Variants of the ring/network coupling	60
5.2	Preparing a Ring/Network Coupling	62
5.2.1	STAND-BY switch	62
5.2.2	One-Switch coupling	65
5.2.3	Two-Switch coupling	71
5.2.4	Two-Switch Coupling with Control Line	79

6	Spanning Tree	87
6.1	The Spanning Tree Protocol	89
6.1.1	The tasks of the STP	89
6.1.2	Bridge parameters	90
6.1.3	Bridge Identifier	90
6.1.4	Root Path Cost	91
6.1.5	Port Identifier	93
6.2	Rules for Creating the Tree Structure	94
6.2.1	Bridge information	94
6.2.2	Setting up the tree structure	94
6.3	Example of determining the root path	97
6.4	Example of manipulating the root path	99
6.5	Example of manipulating the tree structure	101
6.6	The Rapid Spanning Tree Protocol	102
6.6.1	Port roles	102
6.6.2	Port states	105
6.6.3	Spanning Tree Priority Vector	106
6.6.4	Fast reconfiguration	106
6.6.5	Configuring the Rapid Spanning Tree	107
6.7	Combining RSTP and MRP	116
6.7.1	Application example for the combination of RSTP and MRP	118
A	Readers' Comments	121
B	Index	123
C	Further Support	125

About this Manual

The “Redundancy Configuration” user manual document contains the information you require to select the suitable redundancy procedure and configure it.

The “Basic Configuration” user manual contains the information you need to start operating the device. It takes you step by step from the first startup operation through to the basic settings for operation in your environment.

The “Installation” user manual contains a device description, safety instructions, a description of the display, and the other information that you need to install the device.

The “Industry Protocols” user manual describes how the device is connected by means of a communication protocol commonly used in the industry, such as EtherNet/IP and PROFINET IO.

The “Graphical User Interface” reference manual contains detailed information on using the Graphical User Interface to operate the individual functions of the device.





The “Command Line Interface” reference manual contains detailed information on using the Command Line Interface to operate the individual functions of the device.

The Industrial HiVision Network Management Software provides you with additional options for smooth configuration and monitoring:





- ▶ Simultaneous configuration of multiple devices
- ▶ Graphical user interface with network layout
- ▶ Auto-topology discovery
- ▶ Event log
- ▶ Event handling
- ▶ Client/server structure
- ▶ Browser interface
- ▶ ActiveX control for SCADA integration
- ▶ SNMP/OPC gateway.

Key

The designations used in this manual have the following meanings:

	List
<input type="checkbox"/>	Work step
	Subheading
Link	Cross-reference with link
Note:	A note emphasizes an important fact or draws your attention to a dependency.
<code>Courier</code>	ASCII representation in user interface
	Execution in the Graphical User Interface
	Execution in the Command Line Interface

Symbols used:

	WLAN access point
	Router with firewall
	Switch with firewall
	Router
	Switch

Key



Bridge



Hub



A random computer



Configuration Computer



Server



PLC -
Programmable logic
controller



I/O -
Robot

1 Introduction

The device contains a range of redundancy functions:

- ▶ Link Aggregation
- ▶ HIPER-Ring
- ▶ MRP-Ring
- ▶ Fast HIPER-Ring (RSR20, RSR30 and MACH 1000)
- ▶ Sub-Ring (RSR20, RSR30 and MACH 1000)
- ▶ Ring/Network coupling
- ▶ Rapid Spanning Tree Algorithm (RSTP)

1.1 Overview of Redundancy Topologies

To introduce redundancy onto layer 2 of a network, you first define which network topology you require. Depending on the network topology selected, you then choose from the redundancy protocols that can be used with this network topology.

The following topologies are possible:

Network topology	Possible redundancy procedures	Comments
Tree structure without loops (cycle-free)	Only possible in connection with physical loops	-
Topology with 1 loop	RSTP Ring Redundancy	Ring Redundancy procedures (HIPER-Ring, Fast HIPER-Ring or MRP) provide shorter switching times than RSTP.
Topology with 2 loops	RSTP Ring Redundancy Sub-Ring (RSR20, RSR30, PowerMICE, MACH 1000 and MACH 4000)	Ring redundancy: a Basis-Ring with a Sub-Ring or an MRP-Ring with an RSTP-Ring.
Topology with 3 non-nested loops	RSTP Ring Redundancy Sub-Ring (RSR20, RSR30, PowerMICE, MACH 1000 and MACH 4000) Ring coupling	The ring coupling provides particular support when redundantly coupling a redundant ring to another redundant ring, or to any structure that only works with Hirschmann devices
Topology with nested loops	RSTP Sub-Ring (RSR20, RSR30, PowerMICE, MACH 1000 and MACH 4000) Ring coupling	Ring coupling only couples non-nested rings, though these can couple local Sub-Rings.

Table 1: Overview of Redundancy Topologies

The Ring Redundancy Protocol MRP has particular properties to offer:

- ▶ You have the option of nesting MRP-Rings. A coupled ring is known as a Sub-Ring ([see on page 46 “Sub-Ring”](#)).
- ▶ You have the option of coupling to MRP-Rings other ring structures that work with RSTP ([see on page 116 “Combining RSTP and MRP”](#)).

1.2 Overview of Redundancy Protocols

Redundancy procedure	Network topology	Switch-over time
RSTP	Random structure	typically < 1 s (STP < 30 s), up to < 30 s - depends heavily on the number of devices
		Note: Up to 79 devices possible, depending on topology and configuration. If the default values (factory settings) are used, up to 39 devices are possible, depending on the topology (see on page 87 “Spanning Tree”).
HIPER-Ring	Ring	typically 80 ms, up to < 500 ms or < 300 ms (selectable) - the number of switches has a minimal effect on the switch-over time
MRP-Ring	Ring	typically 80 ms, up to < 500 ms or < 200 ms (selectable) - the number of switches has a minimal effect on the switch over time
		Note: In combination with RSTP in MRP compatibility mode, up to 39 devices are possible, depending on the configuration. If the default values (factory settings) for RSTP are being used, up to 19 devices are possible (see on page 87 “Spanning Tree”).
Fast HIPER-Ring (RSR20, RSR30 and MACH 1000)	Ring	< 10 ms with 5 devices in ring. With more than 5 devices, the switching time increases.
Sub-Ring (RSR20, RSR30, PowerMICE, MACH 1000 and MACH 4000)	Ring segment coupled to a primary ring	typically 80 ms, up to < 500 ms or < 200 ms (selectable) - the number of switches has a minimal effect on the switch over time
Link Aggregation	Coupling of network segments via parallel active lines with dynamic load distribution and line redundancy	

Table 2: Comparison of the redundancy procedures

Note: When you are using a redundancy function, you deactivate the flow control on the participating device ports. If the flow control and the redundancy function are active at the same time, there is a risk that the redundancy function will not operate as intended.

2 Link Aggregation

The LACP (Link Aggregation Control Protocol based on IEEE 802.3ad) is a network protocol for dynamically bundling physical network connections. The added bandwidth of all connection lines is available for data transmission. In the case of a connection breaking down, the remaining connections take over the entire data transmission (redundancy). The load distribution between the connection lines is performed automatically.

You configure a link aggregation by combining at least 2 existing parallel redundant connection lines (known as a trunk) between two devices into one logical connection. You can use link aggregation to combine up to 8 (optimally up to 4) connection lines between devices into a trunk.

Any combination of twisted pair and F/O cables can be used as the connection lines of a trunk. Configure the connections so that the data rates and the duplex settings of the related ports are matching.

The maximum that can exit a device are

- 2 trunks for rail devices with 4 ports,
- 4 trunks for rail and MICE devices with 8-10 ports,
- 7 trunks for all other devices.

2.1 Example of link aggregation

In a network consisting of seven devices in a line topology, there are two segments with a particularly large amount of data traffic. You therefore decide to set up link aggregations in these segments. As well as dividing the load over several lines, you also get increased reliability in these segments through the redundant lines.

The link aggregation LATP (Link Aggregation Twisted Pair) consists of 3 twisted pair lines, and the link aggregation LAFO (Link Aggregation Fiber Optic) consists of 2 glass fiber lines.

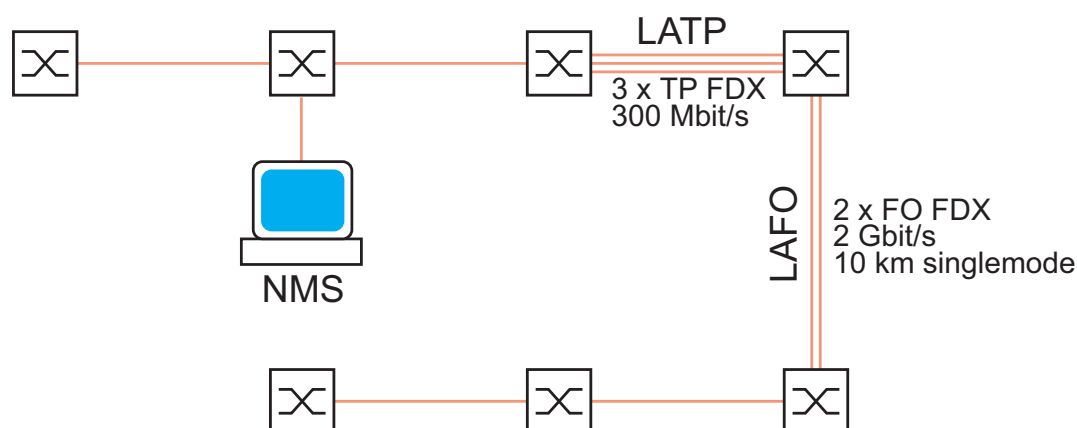

Figure 1: Example of link aggregation
NMS = Network Management Station
LATP = Link Aggregation Twisted Pair
LAFO = Link Aggregation Fiber Optic

The following example describes the configuration of the LATP link aggregation. For this link aggregation, you provide three free twisted pair ports at each of the two participating devices. (Connection: Module1 Port1 to Port3).

2.1.1 Creating and configuring the link aggregation

Note: A link aggregation connects exactly 2 devices.

You configure the link aggregation on each of the 2 devices involved. During the configuration phase, you connect only one single connection line between the devices. This is to avoid loops.

- Under `Basic Settings:Port Configuration`, you configure all three connections so that the transmission rate and the duplex settings of the participating ports on both devices are matching.
- Among the devices involved in a link aggregation, you define that device that has the most devices between itself and the device to which the configuration PC/(NMS network management station) is connected. You begin the configuration at this device, otherwise the Link Aggregation Control Protocol (LACP) can block ports and disconnect devices from the network, so that they cannot be configured any more.
- In the example below (see figure 2), you configure the link aggregation first on device 3, then on device 2. If you accidentally disconnect device 3 from the network, you can access it again by selecting “Allow static link aggregation” in the `Redundancy: Link Aggregation` dialog, or by activating this option via the CLI.

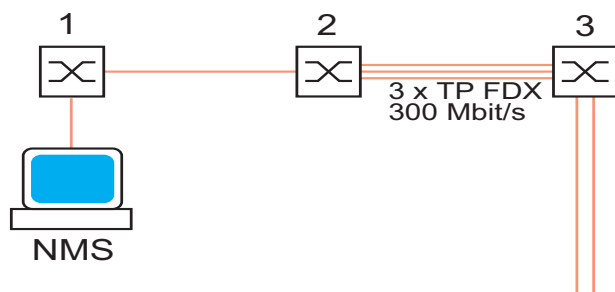

Figure 2: Example: “Defining the first device”
NMS = Network Management Station

- Proceed as follows to configure a link aggregation from 3 twisted pair lines on device 3:

- Select the Redundancy:Link Aggregation (see figure 3) dialog.

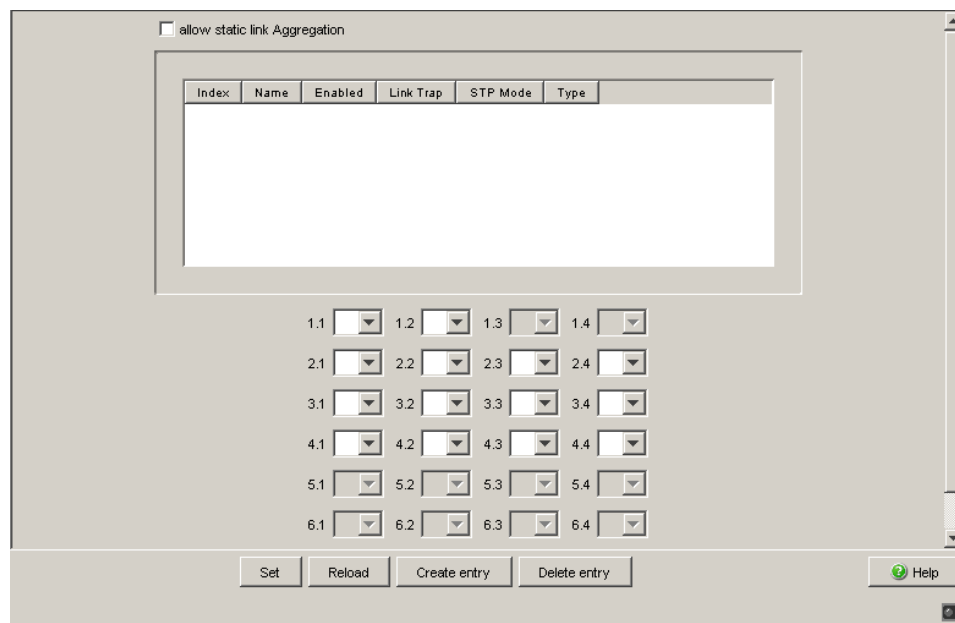

Figure 3: Creating the link aggregation

- Select Allow static link aggregation if the partner device does not support the Link Aggregation Control Protocol (LACP) (e.g. MACH 3000).
- Click “Create entry” to create a new link aggregation.
- The `Index` column shows you the ID under which the device uses a link aggregation (a trunk) as a virtual port. The device creates the port in module 8, which does not physically exist, and the first link aggregation then has the ID 8.1.
- The `Name` column allows you to give this connection any name you want. In this example, you give the new link aggregation the name “LAPT”.
- The `Enabled` column allows you to enable/disable a link aggregation that has been set up. Leave the checkmark in the “Enabled” column while you are using the link aggregation.

- Leave the checkmark in the `Link Trap` column if you want the device to generate an alarm if all the connections of the link aggregation are interrupted.
 - In the “STP Mode” column, you select `on` if the link aggregation connection is connected to a Spanning Tree, `off` if no Spanning Tree is active, or if the link aggregation is a segment of a HIPER-Ring.
 - “Type” shows whether you created this link aggregation manually (Allow static link aggregation is selected), or whether it was created dynamically using LACP (Allow static link aggregation is not selected).
- Note:** If there are multiple connections between devices that support LACP, and if Allow static link aggregation is nevertheless selected, `dynamic` is still displayed, because in this case the devices automatically switch to dynamic.

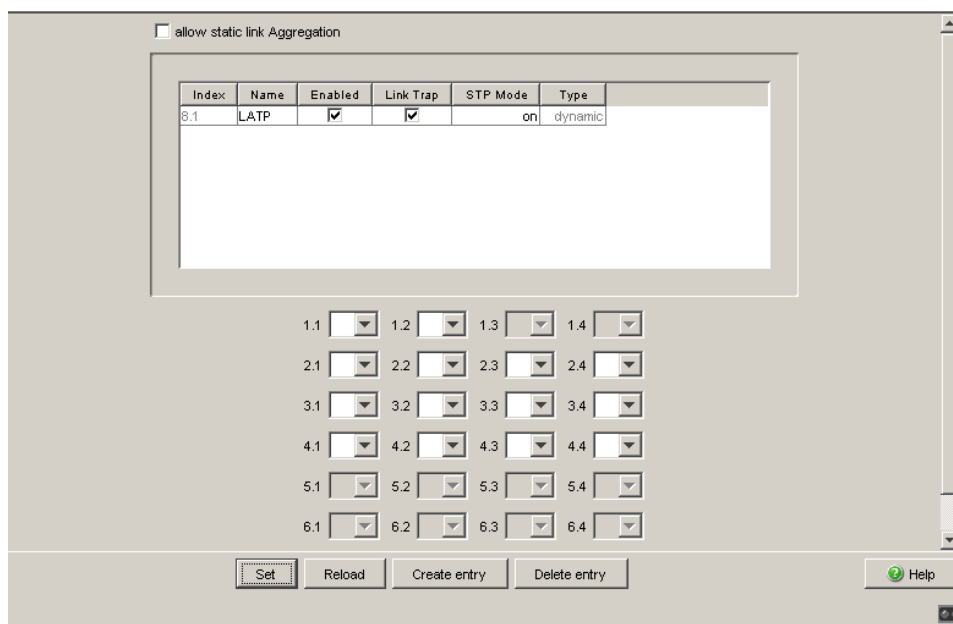

Figure 4: Link aggregation created and named.

- Now assign to the ports participating in the link aggregation (ports 1.1, 1.2 and 1.3) the index of the link aggregation connection LAPT (8.1). (see figure 5).

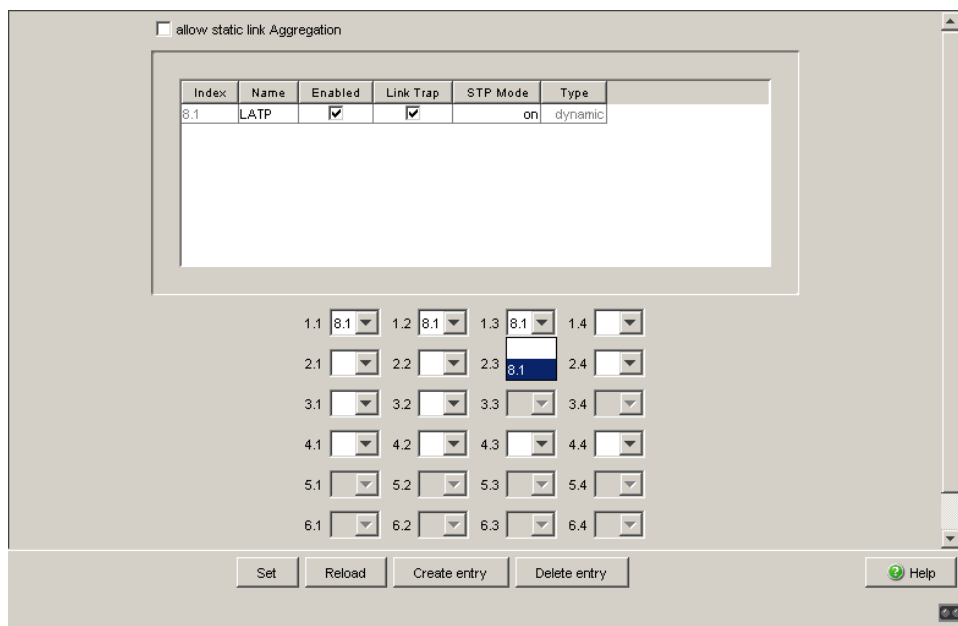

Figure 5: Assigning ports to link aggregation

```

enable
configure
link-aggregation LAMP
New link aggregation created. Slot/port is 8.1.
Interface 1/1
addport 8/1
Interface 1/2
addport 8/1
Interface 1/3
addport 8/1
exit
show link-aggregation brief
Max. num. of LAGs: 7
Slot no. for LAGs: 8
Static Capability: Disabled
Logical Link-Aggr.
Interface Name Link State Mbr Ports Active Ports
-----
8/1 LAMP Down 1/1,1/2, 1/3
    
```

- Now you configure the partner device (device 2) in the same way.
- After the configuration, you connect the other connection line(s) between the devices.

Note: Exclude the combination of a link aggregation with the following redundancy procedures:

- ▶ Network/Ring coupling
- ▶ MRP-Ring
- ▶ Fast HIPER-Ring
- ▶ Sub-Ring

2.2 HIPER-Ring and Link Aggregation

To increase the availability on particularly important connections, you can combine the HIPER-Ring (see on page 25 “Ring Redundancy”) and link aggregation redundancy functions.

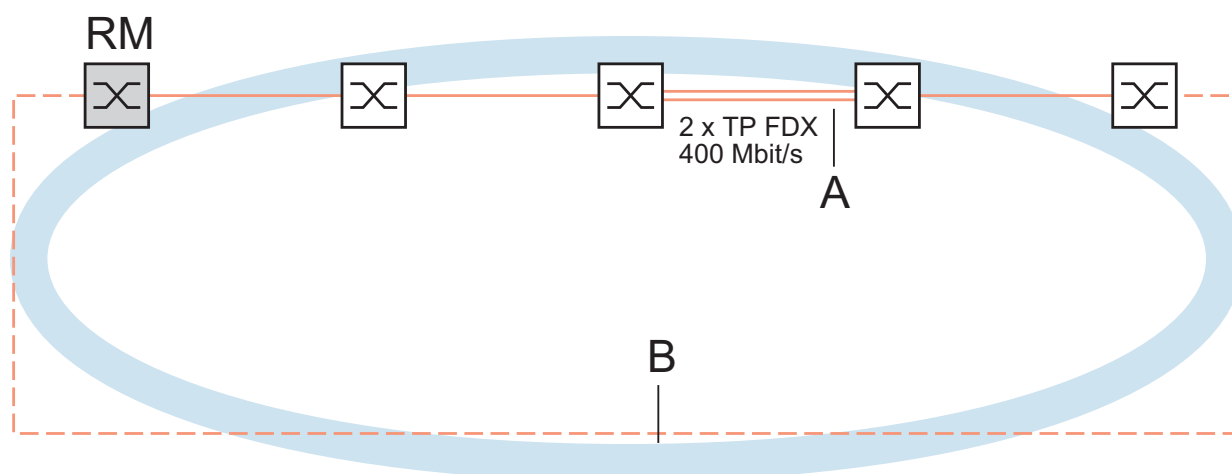

Figure 6: Example of a HIPER-Ring / link aggregation combination
RM = Ring Manager
A = link aggregation
B = HIPER-Ring

The above example shows a HIPER-Ring. One link aggregation forms a segment of the ring. When all the connection lines of the link aggregation are interrupted, the HIPER-Ring function activates the redundant line of the ring.

Note: If you want to use a link aggregation in a HIPER-Ring, you first configure the link aggregation, then the HIPER-Ring. In the HIPER-Ring dialog, you enter the index of the desired link aggregation as the value for the module and the port (8.x). Ascertain that the respective ring port belongs to the selected link aggregation.

Note: Deactivate RSTP when link aggregations are segments of a HIPER-Ring.

3 Ring Redundancy

The concept of ring redundancy allows the construction of high-availability, ring-shaped network structures.

With the help of the RM (**R**ing **M**anager) function, the two ends of a backbone in a line structure can be closed to a redundant ring. The ring manager keeps the redundant line open as long as the line structure is intact. If a segment becomes inoperable, the ring manager immediately closes the redundant line, and line structure is intact again.

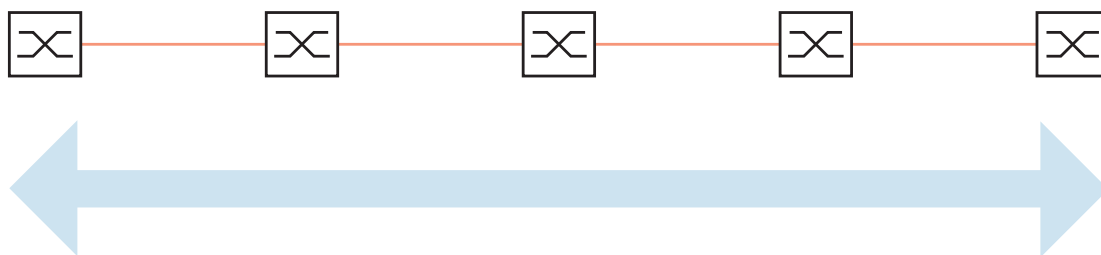

Figure 7: Line structure

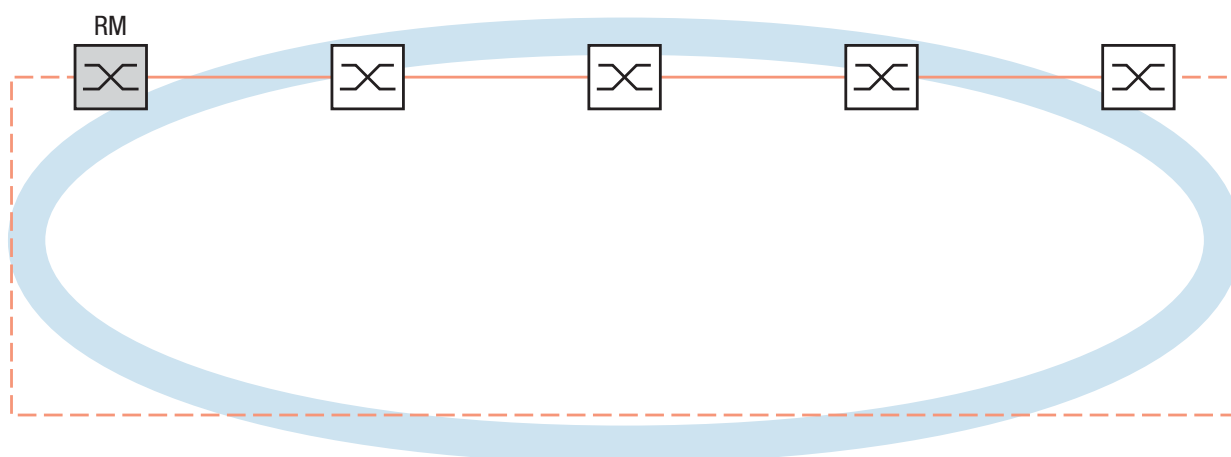

Figure 8: Redundant ring structure

RM = Ring Manager

— main line

- - - redundant line

If a section is down, the ring structure of a

- ▶ **HIPER-(HIGH PERFORMANCE REDUNDANCY)** Ring with up to 50 devices typically transforms back to a line structure within 80 ms (possible settings: standard/accelerated).
- ▶ **MRP (Media Redundancy Protocol)** Ring (IEC 62439) of up to 50 devices typically transforms back to a line structure within 80 ms (adjustable to max. 200 ms/500 ms).
- ▶ **Fast HIPER-Ring** of up to 5 devices typically transforms back to a line structure within 5 ms (maximum 10 ms). With a larger number of devices, the reconfiguration time increases.

Devices with HIPER-Ring function capability:

- ▶ Within a HIPER-Ring, you can use any combination of the following devices:
 - RS1
 - RS2-./.
 - RS2-16M
 - RS2-4R
 - RS20, RS30, RS40
 - RSR20, RSR30
 - OCTOPUS
 - MICE
 - MS20, MS30
 - PowerMICE
 - MACH 100
 - MACH 1000
 - MACH 1040
 - MACH 3000
 - MACH 4000
- ▶ Within an MRP-Ring, you can use devices that support the MRP protocol based on IEC62439.
- ▶ Within a Fast HIPER-Ring, you can use any combination of the following devices:
 - RSR20/RSR30
 - MACH 1000
 - MACH 1040

Note: Only one Ring Redundancy method can be enabled on one device at any one time. When changing to another Ring Redundancy method, deactivate the function for the time being.

Note: The following usage of the term “ring manager” instead of “redundancy manager” makes the function easier to understand.

3.1 Example of a HIPER-Ring

A network contains a backbone in a line structure with 3 devices. To increase the redundancy reliability of the backbone, you have decided to convert the line structure to a HIPER-Ring. You use ports 1.1 and 1.2 of the devices to connect the lines¹.

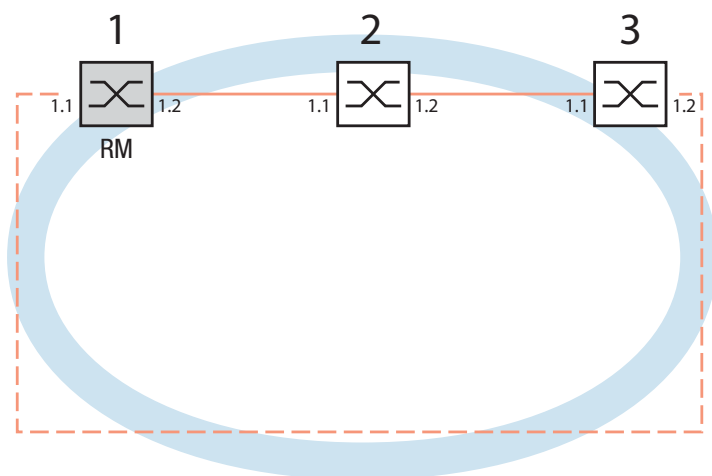

Figure 9: Example of HIPER-Ring
RM = Ring Manager
— main line
- - - redundant line

The following example configuration describes the configuration of the ring manager device (1). The two other devices (2 to 3) are configured in the same way, but without activating the ring manager function. Select the “Standard” value for the ring recovery, or leave the field empty.

1. On modular devices the 1st number of the port designation specifies the module. The 2nd number specifies the port on the module. The specification pattern 1.x is also used on non-modular devices for consistency.

Note: As an alternative to using software to configure the HIPER-Ring, with the RS20/30/40, MS20/30 and PowerMICE Switches, you can also use DIP switches to enter a number of settings on the devices. You can also use a DIP switch to enter a setting for whether the configuration via DIP switch or the configuration via software has priority. The state on delivery is “Software Configuration”. You will find details on the DIP switches in the “Installation” user manual.

Note: Configure all the devices of the HIPER-Ring individually. Before you connect the redundant line, you must complete the configuration of all the devices of the HIPER-Ring. You thus avoid loops during the configuration phase.

3.1.1 Setting up and configuring the HIPER-Ring

- Set up the network to meet your demands.
- Configure all ports so that the transmission speed and the duplex settings of the lines correspond to the following table:

Port type	Bit rate	Autonegotiation (automatic configuration)	Port setting	Duplex
TX	100 Mbit/s	off	on	100 Mbit/s full duplex (FDX)
TX	1 Gbit/s	on	on	-
Optical	100 Mbit/s	off	on	100 Mbit/s full duplex (FDX)
Optical	1 Gbit/s	on	on	-
Optical	10 Gbit/s	-	on	10 Gbit/s full duplex (FDX)

Table 3: Port settings for ring ports

Note: When activating the HIPER-Ring function via software or DIP switches, the device sets the corresponding settings for the pre-defined ring ports in the configuration table (transmission rate and mode). If you switch off the HIPER-Ring function, the ports, which are changed back into normal ports, keep the ring port settings. Independently of the DIP switch setting, you can still change the port settings via the software.

- Select the `Redundancy:Ring Redundancy` dialog.
- Under “Version”, select `HIPER-Ring`.
- Define the desired ring ports 1 and 2 by making the corresponding entries in the module and port fields. If it is not possible to enter a module, then there is only one module in the device that is taken over as a default.

Display in “Operation” field:

- `active`: This port is switched on and has a link.
- `inactive`: This port is switched off or it has no link.

Figure 10: Ring Redundancy dialog (RSR20, RSR30, MACH 1000)

- Activate the ring manager for this device. Do not activate the ring manager for any other device in the HIPER-Ring.
 - In the “Ring Recovery” frame, select the value “Standard” (default).
- Note:** Settings in the “Ring Recovery” frame are only effective for devices that you have configured as ring managers.
- Click "Set" to save the changes temporarily.

```

enable                               Switch to the privileged EXEC mode.
configure                             Switch to the Configuration mode.
hiper-ring mode ring-manager          Select the HIPER-Ring ring redundancy and
                                       define the device as ring manager.

Switch's HIPER Ring mode set to ring-manager
hiper-ring port primary 1/1           Define port 1 in module 1 as ring port 1.
HIPER Ring primary port set to 1/1
hiper-ring port secondary 1/2        Define port 2 in module 1 as ring port 2.
HIPER Ring secondary port set to 1/2
exit                                  Switch to the privileged EXEC mode.

```

```

show hiper-ring                Display the HIPER-Ring parameters.
HIPER Ring Mode of the Switch..... ring-manager
  configuration determined by..... management
HIPER Ring Primary Port of the Switch..... 1/1, state active
HIPER Ring Secondary Port of the Switch..... 1/2, state active
HIPER Ring Redundancy Manager State..... active
HIPER Ring Redundancy State (red. exists).. no (rm is active)
HIPER Ring Setup Info (Config. failure)..... no error
HIPER Ring Recovery Delay..... 500ms

```

Now proceed in the same way for the other two devices.

Note: If you have configured VLANs, note the VLAN configuration of the ring ports.

In the configuration of the HIPER-Ring, you select for the ring ports

- VLAN ID 1 and “Ingress Filtering” disabled in the port table and
- VLAN membership U in the static VLAN table.

Note: Deactivate the Spanning Tree protocol for the ports connected to the HIPER-Ring, because Spanning Tree and Ring Redundancy affect each other.

If you used the DIP switch to activate the function of HIPER-Ring, RSTP is automatically switched off.

Now you connect the line to the ring. To do this, you connect the 2 devices to the ends of the line using their ring ports.

The displays in the “Redundancy Manager Status” frame mean:

- “Active (redundant line)”: The ring is open, which means that a data line or a network component within the ring is down.
- “Inactive”: The ring is closed, which means that the data lines and network components are working.

The displays in the “Information” frame mean

- “Redundancy existing”: One of the lines affected by the function may be interrupted, with the redundant line then taking over the function of the interrupted line.
- “Configuration failure”: The function is incorrectly configured or the cable connections at the ring ports are improperly configured (e.g., not plugged into the ring ports).

Note: If you want to use link aggregation connections in the HIPER-Ring (PowerMICE and MACH 4000), you enter the index of the desired link aggregation entry for the module and the port.

3.2 Example of a MRP-Ring

A network contains a backbone in a line structure with 3 devices. To increase the availability of the backbone, you decide to convert the line structure to a redundant ring. In contrast to the previous example, devices from different manufacturers are used which do not all support the HIPER-Ring protocol. However, all devices support MRP as the ring redundancy protocol, so you decide to deploy MRP. You use ports 1.1 and 2.2 of the devices to connect the lines.

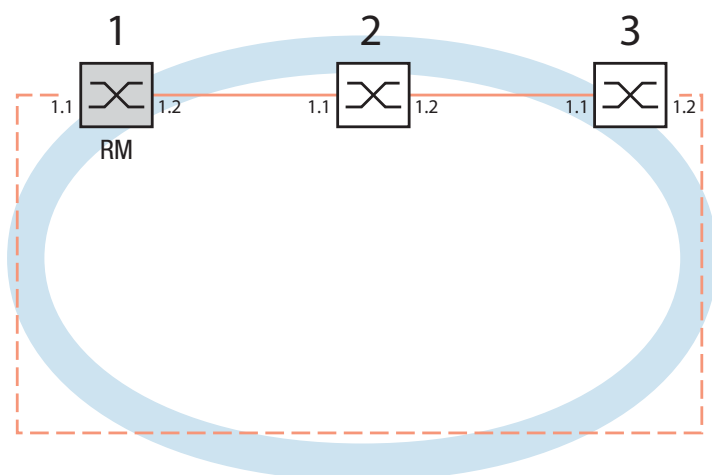

Figure 11: Example of MRP-Ring
RM = Ring Manager
— main line
- - - redundant line

The following example configuration describes the configuration of the ring manager device (1). You configure the 2 other devices (2 to 3) in the same way, but without activating the ring manager function. This example does not use a VLAN. You have entered 200 ms as the ring recovery time, and all the devices support the advanced mode of the ring manager.

Note: For devices with DIP switches, put all DIP switches to “On”. The effect of this is that you can use the software configuration to configure the redundancy function without any restrictions. You thus avoid the possibility of the software configuration being hindered by the DIP switches.

Note: Configure all the devices of the MRP-Ring individually. Before you connect the redundant line, you must have completed the configuration of all the devices of the MRP-Ring. You thus avoid loops during the configuration phase.

- Set up the network to meet your demands.
- Configure all ports so that the transmission speed and the duplex settings of the lines correspond to the following table:

Port type	Bit rate	Autonegotiation (automatic configuration)	Port setting	Duplex
TX	100 Mbit/s	off	on	100 Mbit/s full duplex (FDX)
TX	1 Gbit/s	on	on	-
Optical	100 Mbit/s	off	on	100 Mbit/s full duplex (FDX)
Optical	1 Gbit/s	on	on	-
Optical	10 Gbit/s	-	on	10 Gbit/s full duplex (FDX)

Table 4: Port settings for ring ports

- Select the `Redundancy:Ring Redundancy` dialog.
- Under “Version”, select `MRP`.
- Define the desired ring ports 1 and 2 by making the corresponding entries in the module and port fields. If it is not possible to enter a module, then there is only one module in the device that is taken over as a default.

Display in “Operation” field:

- ▶ forwarding: this port is switched on and has a link.
- ▶ blocked: this port is blocked and has a link
- ▶ disabled: this port is disabled
- ▶ not-connected: this port has no link

Figure 12: Ring Redundancy dialog (RSR20, RSR30, MACH 1000)

- In the “Ring Recovery” frame, select 200 ms.

Note: If selecting 200 ms for the ring recovery does not provide the ring stability necessary to meet the requirements of your network, you select 500 ms.

Note: Settings in the “Ring Recovery” frame are only effective for devices that you have configured as ring managers.

- Under “Configuration Redundancy Manager”, activate the advanced mode.
- Activate the ring manager for this device. Do not activate the ring manager for any other device in the MRP-Ring.
- Leave the VLAN ID as 0 in the VLAN field.
- Switch the operation of the MRP-Ring on.
- Click "Set" to save the changes temporarily.

The displays in the “Information” frame mean

- “Redundancy existing”: One of the lines affected by the function may be interrupted, with the redundant line then taking over the function of the interrupted line.
- “Configuration failure”: The function is incorrectly configured or the cable connections at the ring ports are improperly configured (e.g., not plugged into the ring ports).

The “VLAN” frame enables you to assign the MRP-Ring to a VLAN:

- If VLANs are configured, you make the following selections in the “VLAN” frame:
 - VLAN ID 0, if the MRP-Ring configuration is not to be assigned to a VLAN, as in this example.
Select VLAN ID 1 and VLAN membership \cup (Untagged) in the static VLAN table for the ring ports.
 - A VLAN ID > 0 , if the MRP-Ring configuration is to be assigned to this VLAN.
For all devices in this MRP-Ring, enter this VLAN ID in the MRP-Ring configuration, and then choose this VLAN ID and the VLAN membership Tagged (\mathbb{T}) in the static VLAN table for all ring ports in this MRP-Ring.

Note: If you want to use the RSTP ([see on page 87 “Spanning Tree”](#)) redundancy protocol in an MRP-Ring, switch on the MRP compatibility on all devices in the MRP-Ring in the `Rapid Spanning Tree:Global` dialog as the RSTP (Spanning-Tree) and ring redundancy affect each other. If this is not possible, perhaps because individual devices do not support the MRP compatibility, you deactivate RSTP at the ports connected to the MRP-Ring.

Note: When you are configuring an MRP-Ring using the Command Line Interface, you define an additional parameter. When configured using CLI, an MRP-Ring is addressed via its MRP domain ID. The MRP domain ID is a sequence of 16 number blocks (8-bit values). Use the default domain of 255 255 255 255 255 255 255 255 255 255 255 255 255 255 255 for the MRP domain ID.

This default domain is also used internally for a configuration via the Web-based interface.

Configure all the devices within an MRP-Ring with the same MRP domain ID.

```

enable                               Switch to the privileged EXEC mode.
configure                             Switch to the Configuration mode.
mrp new-domain                         Creates a new MRP-Ring with the default domain
  default-domain                       ID
                                         255.255.255.255.255.255.255.255.255.
                                         255.255.255.255.255.

MRP domain created:
Domain ID:
255.255.255.255.255.255.255.255.255.255.255.255.255
  (Default MRP domain)
mrp current-domain                     Define port 1 in module 1 as ring port 1 (primary).
  port primary 1/1
Primary Port set to 1/1
mrp current-domain                     Define port 2 in module 1 as ring port 2
  port secondary 1/2                   (secondary)
Secondary Port set to 1/2
mrp current-domain mode                 Define this device as the ring manager.
manager
Mode of Switch set to manager
mrp current-domain recovery-           Define 200ms as the value for the "Ring
delay 200ms                             Recovery".
Recovery delay set to 200ms
mrp current-domain advanced-           Activate the "MRP Advanced Mode".
mode enable
Advanced Mode (react on link change) set to Enabled
mrp current-domain                     Activate the MRP-Ring.
  operation enable
Operation set to Enabled
exit                                   Go back one level.
show mrp                               Show the current parameters of the MRP-Ring
                                         (abbreviated display).

Domain ID:
255.255.255.255.255.255.255.255.255.255.255.255.255
  (Default MRP domain)

Configuration Settings:
Advanced Mode (react on link change)... Enabled
Manager Priority..... 32768
Mode of Switch (administrative setting). Manager
Mode of Switch (real operating state)... Manager
Domain Name..... <empty>
Recovery delay..... 200ms
Port Number, Primary..... 1/1, State: Not Connected
Port Number, Secondary..... 1/2, State: Not Connected
VLAN ID..... 0 (No VLAN)
Operation..... Enabled

```

- Now you connect the line to the ring. To do this, you connect the 2 devices to the ends of the line using their ring ports.

3.3 Example of a Fast HIPER-Ring

This example can be set up with models RSR20, RSR30 and MACH 1000. A network contains a backbone in a line structure with 3 devices. To increase the redundancy reliability of the backbone, you have decided to convert the line structure to a ring redundancy. In contrast to the previous example, you need a very short switch-over time in a redundancy case (about 10 ms). Only RSR20/RSR30 and MACH 1000 devices are being used, so you decide on the Fast HIPER-Ring as the ring redundancy protocol. You use ports 1.1 and 1.2 of the devices to connect the lines.

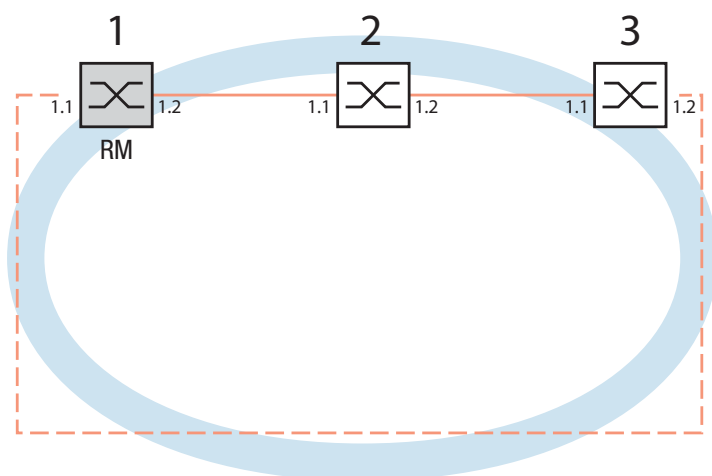

Figure 13: Example of Fast HIPER-Ring
RM = Ring Manager
— main line
- - - redundant line

The following example configuration describes the configuration of the ring manager device (1). The 2 other devices (2 to 3) are configured in the same way, but without activating the ring manager function. No VLAN used in this example.

Note: Configure all the devices of the Fast HIPER-Ring individually. Before you connect the redundant line, you must complete the configuration of all the devices of the Fast HIPER-Ring. You thus avoid loops during the configuration phase.

- Set up the network to meet your demands.
- Configure all ports so that the transmission speed and the duplex settings of the lines correspond to the following table:

Bit rate	100 Mbit/s	1000 Mbit/s
Autonegotiation (automatic configuration)	off	on
Port	on	on
Duplex	Full	–

Table 5: Port settings for ring ports

- Select the `Redundancy:Ring Redundancy` dialog.
- Under “Version”, select `Fast HIPER-Ring`.
- Define the desired ring ports 1 and 2 by making the corresponding entries in the module and port fields. If it is not possible to enter a module, then there is only one module in the device that is taken over as a default.

Display in “Operation” field:

- ▶ `forwarding`: this port is switched on and has a link.
- ▶ `blocked`: this port is blocked and has a link
- ▶ `disabled`: this port is disabled
- ▶ `not-connected`: this port has no link

Figure 14: Ring Redundancy dialog (RSR20, RSR30, MACH 1000)

- Activate the ring manager for this device. Do not activate the ring manager for any other device in the Fast HIPER-Ring.
- Activate the function in the “Operation” frame.
- Leave the VLAN ID as 0 in the VLAN field.
- In the “Switches” frame, enter the number of Switches in the ring in “Number”. This entry is used to optimize the reconfiguration time and the stability of the ring.
- Click "Set" to save the changes temporarily.

The display in the “Ring Information” frame means:

- Round Trip Delay: round-trip delay in μs for test packets, measured by the ring manager.
Display begins with 100 μs , in steps of 100 μs . Values of 1000 μs and greater indicate that the ring may become unstable. In this case, check that the entry for the number of Switches in the “Switches” frame is correct.

The displays in the “Information” frame mean

- “Redundancy existing”: One of the lines affected by the function may be interrupted, with the redundant line then taking over the function of the interrupted line.
- “Configuration failure”: The function is incorrectly configured or the cable connections at the ring ports are improperly configured (e.g., not plugged into the ring ports).

The “VLAN” frame enables you to assign the Fast HIPER-Ring to a VLAN:

- If VLANs are configured, you make the following selections in the “VLAN” frame:
 - VLAN ID 0, if the Fast HIPER-Ring configuration is not to be assigned to a VLAN, as in this example.
Select VLAN ID 1 and VLAN membership \cup (Untagged) in the static VLAN table for the ring ports.
 - A VLAN ID > 0 , if the Fast HIPER-Ring configuration is to be assigned to this VLAN.
For all devices in this Fast HIPER-Ring, enter this VLAN ID in the Fast HIPER-Ring configuration, and then choose this VLAN ID and the VLAN membership \cap (Tagged) in the static VLAN table for all ring ports in this Fast HIPER-Ring.

Note: If you want to configure a Fast HIPER-Ring using the **Command Line Interface (CLI)**, you must define an additional parameter. When configured using CLI, a Fast HIPER-Ring is addressed via its Fast HIPER-Ring ID. This ID is a number in the value range 1 to 2,147,480,647 ($2^{31} - 1$). The default setting is 1. The device also uses this value internally for a configuration via the Web-based interface.

Configure all the devices within a Fast HIPER-Ring with the same Fast HIPER-Ring ID.

```
enable
configure
fast-hiper-ring new-id
default-id
```

```
Fast HIPER-Ring ID created:ID: 1 (Default Fast HIPER-Ring ID)
```

```
fast-hiper-ring current-id
mode ring-manager
```

```
Mode of Switch set to Ring Manager
```

Switch to the privileged EXEC mode.

Switch to the Configuration mode.

Create a new Fast HIPER-Ring with the default ID (1). Ports 1/1 and 1/2 are defined as ring ports here. You keep these default values.

Define this device as the ring manager.

```

fast-hiper-ring current-id      Define the number of devices in the Fast HIPER-
nodes 3                         Ring as 3.

Number of nodes set to 3

fast-hiper-ring current-id      Activate the Fast HIPER-Ring.
operation enable

Operation set to Enabled

exit                             Switch to the Configuration mode.

show fast-hiper-ring           Show the current parameters of the Fast HIPER-
                                Ring.

Ring ID: 1
      (Default Fast HIPER-Ring ID)
Mode of Switch (administrative setting). Ring Manager
Mode of Switch (real operating state)... Ring Manager
Ring Name.....<empty>
Number of nodes in the ring..... 3
Port Number, Primary..... 1/1, State: Not Connected
Port Number, Secondary..... 1/2, State: Not Connected
VLAN ID..... 0 (No VLAN)
Operation..... Enabled

General Operating States:
FHR Setup Info (Config. Failure)..... Ring Port Link Error

Manager-related Operating States:
Ring State..... Open
Redundancy Guaranteed..... No
Round Trip Delay..... 0

```

Note: Deactivate the Spanning Tree protocol (STP) for the ports connected to the redundant ring, because the Spanning Tree and the Ring Redundancy work with different reaction times (Redundancy:Spanning Tree:Port).

- Now you connect the line to the ring. To do this, you connect the 2 devices to the ends of the line using their ring ports.

4 Multiple Rings

The device allows you to set up multiple rings with different redundancy protocols:

- ▶ You have the option of nesting MRP-Rings. A coupled ring is known as a Sub-Ring ([see on page 46 “Sub-Ring”](#)).
- ▶ You have the option of coupling to MRP-Rings other ring structures that work with RSTP ([see on page 116 “Combining RSTP and MRP”](#)).

4.1 Sub-Ring

4.1.1 Sub-Ring description

For the devices RSR20, RSR30, PowerMICE, MACH 1000, MACH 1040, and MACH 4000.

The Sub-Ring concept enables you to easily couple new network segments to suitable devices in existing redundancy rings (primary rings). The devices of the primary ring to which the new Sub-Ring is being coupled are referred to as Sub-Ring Managers (SRMs).

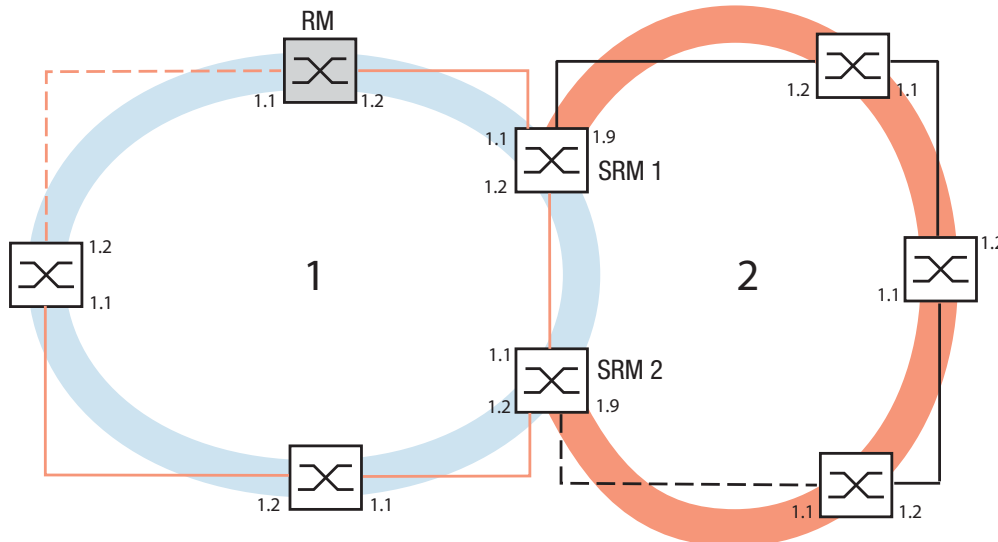

Figure 15: Example of a Sub-Ring structure

1 blue ring = basis ring

2 orange ring = Sub-Ring

SRM = Sub-Ring Manager

RM = Ring Manager

Note: The following devices support the Sub-Ring Manager function:

- RSR20/RSR30
- MACH 1000
- MACH 1040
- MACH 4000
- PowerMICE

The SRM-capable devices support up to 4 SRM instances (MACH 1040 up to 8) and can thus be the Sub-Ring manager for up to 4 Sub-Rings at the same time (MACH 1040 for up to 8).

In a Sub-Ring, you can integrate as participants the devices that support MRP - the Sub-Ring Manager function is not required.

Each Sub Ring may consist of up to 200 participants. The SRMs themselves and the switches placed in the Base Ring between the SRMs do not count here.

Setting up Sub-Rings has the following advantages:

- ▶ Through the coupling process, you include the new network segment in the redundancy concept.
- ▶ You can easily integrate new company areas into existing networks.
- ▶ You easily map the organizational structure of a company in the network topology.
- ▶ As an MRP-Ring, the switching times of the Sub-Ring in redundancy cases are typically < 100 ms.

The following graphics show examples of possible Sub-Ring topologies:

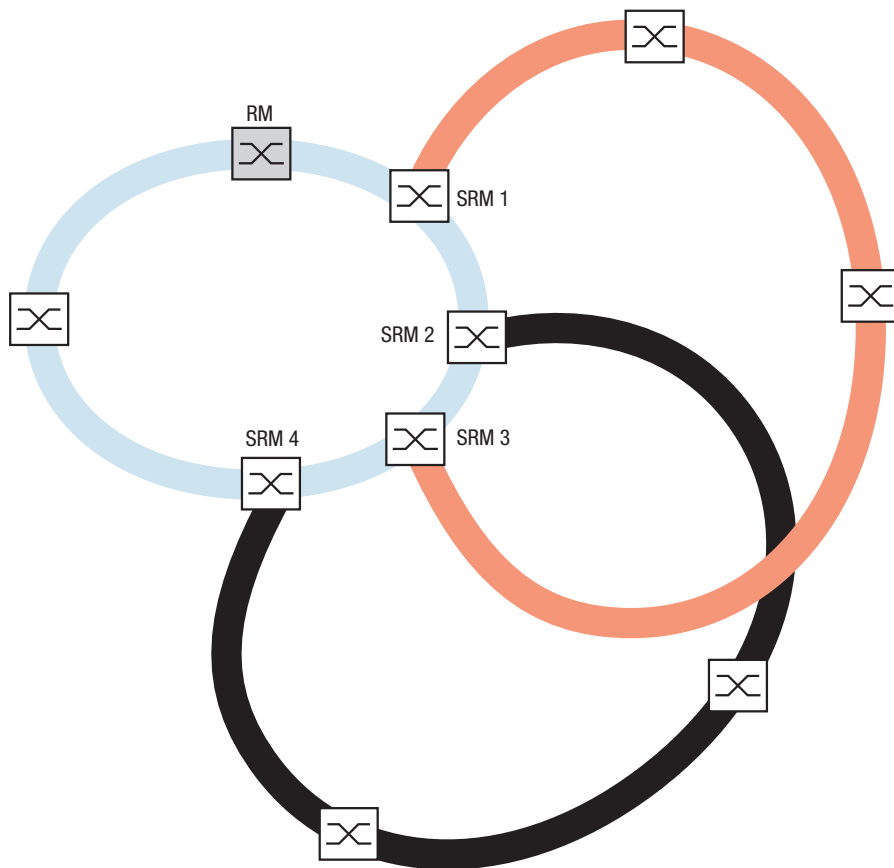

Figure 16: Example of an overlapping Sub-Ring structure

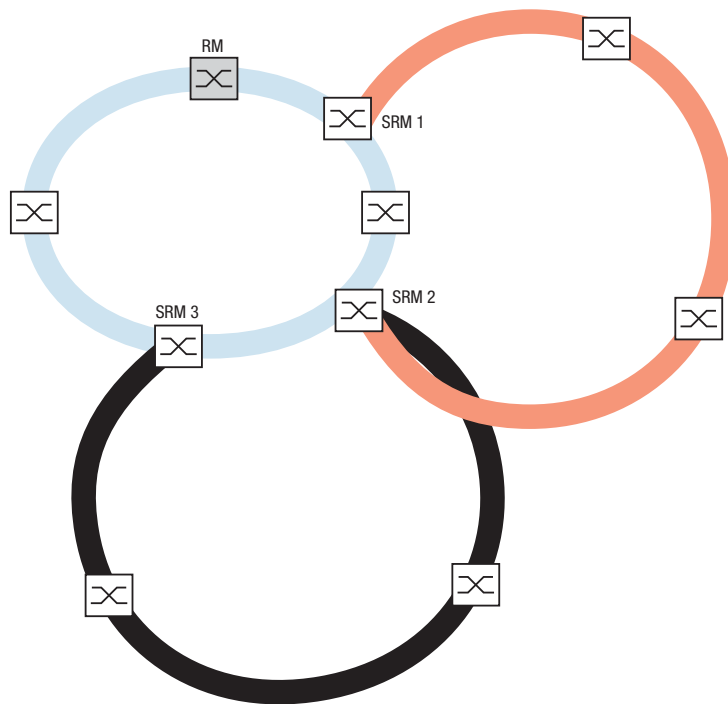

Figure 17: Special case: a Sub-Ring Manager manages 2 Sub-Rings (2 instances). Depending on the device type, you can configure additional instances.

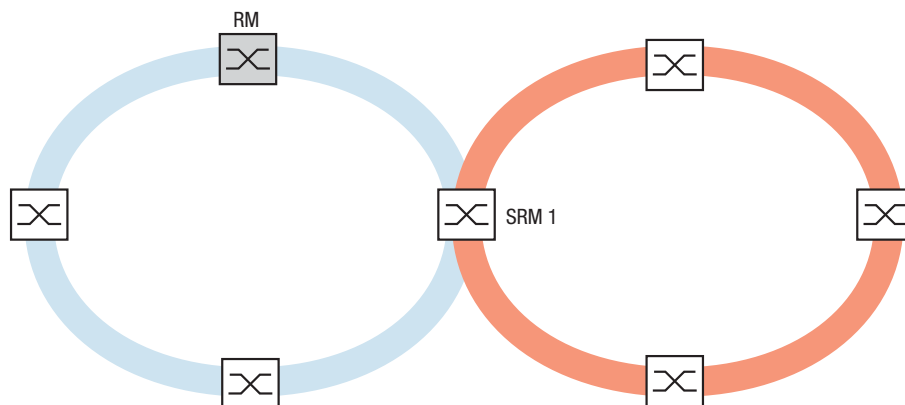

Figure 18: Special case: a Sub-Ring Manager manages both ends of a Sub-Ring at different ports (Single Sub-Ring Manager).

Note: Connect Sub-Rings only to existing primary rings. Do not cascade Sub-Rings (i.e., a new Sub-Ring must not be connected to an existing Sub-Ring).

Note: Sub-Rings use MRP. You can couple Sub-Rings to existing primary rings with the HIPER-Ring protocol, the Fast HIPER-Ring protocol and MRP. If you couple a Sub-Ring to a primary ring under MRP, configure both rings in different VLANs. You configure

- ▶ either the Sub-Ring Managers' Sub-Ring ports and the devices of the Sub-Ring in a separate VLAN. Here multiple Sub-Rings can use the same VLAN.
- ▶ or the devices of the primary ring including the Sub-Ring Managers' primary ring ports in a separate VLAN. This reduces the configuration effort when coupling multiple Sub-Rings to a primary ring.

4.1.2 Sub-Ring example

You want to couple a new network segment with 3 devices to an existing redundant ring with the HIPER-Ring protocol. If you couple the network at both ends instead of only one end, this provides increased availability with the corresponding configuration.

The new network segment is connected as a Sub-Ring. The connection is made to existing devices of the basis ring with the following types:

- RSR20/RSR30
- MACH 1000
- MACH 1040
- MACH 4000
- PowerMICE

Configure these devices as Sub-Ring Managers.

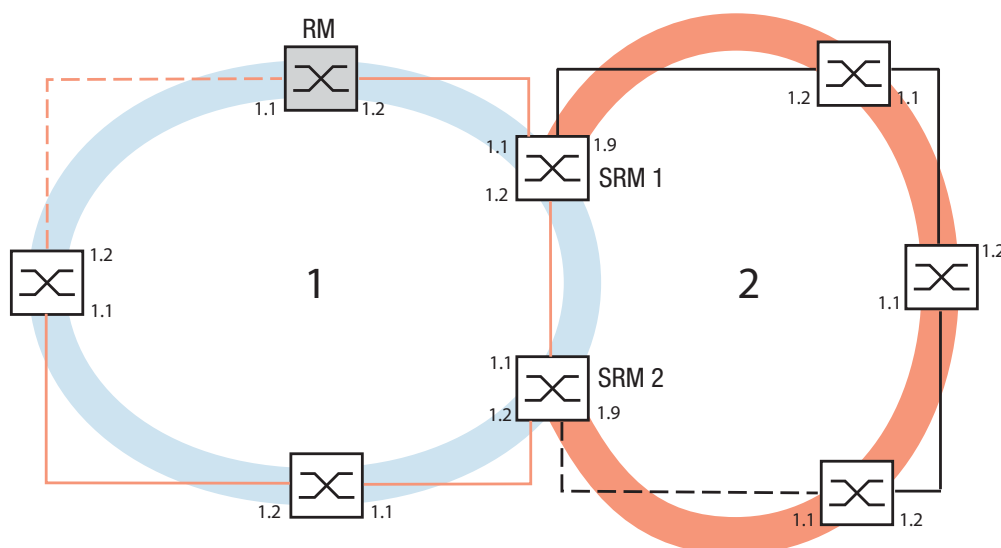

Figure 19: Example of a Sub-Ring structure

1 blue ring = basis ring

2 orange ring = Sub-Ring

SRM = Sub-Ring Manager

RM = Ring Manager

Proceed as follows to configure a Sub-Ring:

- Configure the three devices of the new network segment as participants in an MRP-Ring. This means:
 - Configure the transmission rate and the duplex mode for all the ring ports in accordance with the following table:

Port type	Bit rate	Autonegotiation (automatic configuration)	Port setting	Duplex
TX	100 Mbit/s	off	on	100 Mbit/s full duplex (FDX)
TX	1 Gbit/s	on	on	-
Optical	100 Mbit/s	off	on	100 Mbit/s full duplex (FDX)
Optical	1 Gbit/s	on	on	-
Optical	10 Gbit/s	-	on	10 Gbit/s full duplex (FDX)

Table 6: Port settings for ring ports

□ Other settings:

- Define a different VLAN membership for the Primary Ring and the Sub-Ring even if the basis ring is using the MRP protocol, e.g. VLAN ID 1 for the Primary Ring and VLAN ID 2 for the Sub-Ring.
- For all ring ports in the Sub-Ring, select this VLAN ID and the VLAN membership Tagged (T) in the static VLAN table.
- Switch the MRP-Ring function on for all devices.
- In the Ring Redundancy dialog, under MRP-Ring, configure for all devices the two ring ports used in the Sub-Ring.
- Switch the Ring Manager function off for all devices.
- Do not configure link aggregation.
- Switch RSTP off for the MRP Ring ports used in the Sub-Ring.
- Assign the same MRP domain ID to all devices. If you are only using Hirschmann Automation and Control GmbH devices, you do not have to change the default value for the MRP domain ID.

Note: The MRP domain ID is a sequence of 16 numbers (range 0 to 255). The default domain (in the CLI: “default-domain“) is the MRP domain ID of 255 255 255 255 255 255 255 255 255 255 255 255 255 255 255 255. A MRP domain ID consisting entirely of zeroes is invalid.

If you need to adjust the MRP domain ID, open the Command Line Interface (CLI) and proceed as follows:

<pre>enable configure mrp delete-domain current-domain</pre>	<p>Switch to the privileged EXEC mode.</p> <p>Switch to the Configuration mode.</p> <p>Deletes the current MRP domain. If no MRP domain exists, the device outputs an error message.</p>
<pre>MRP current domain deleted: Domain ID: 255.255.255.255.255.255.255.255.255.255.255.255.255.255 (Default MRP domain)</pre>	

```
mrp new-domain
  0.0.1.1.2.2.3.4.4.111.
  222.123.0.0.66.99
MRP domain created:
Domain ID: 0.0.1.1.2.2.3.4.5.111.222.123.0.0.66.99
```

Creates a new MRP domain with the specified MRP domain ID. You can subsequently access this domain with “current-domain”.

4.1.3 Sub-Ring example configuration

Note: Avoid loops during the configuration phase. Configure all the devices of the Sub-Ring individually. Before you connect the redundant line (close the Sub-Ring), you must complete the configuration of all the devices of the Sub-Ring.

Proceed as follows to configure the 2 Sub-Ring Managers in the example:

- Select the `Redundancy:Sub-Ring` dialog.
- Click the button "New".

Figure 20: Sub-Ring – New Entry dialog

- Enter the value “1” as the ring ID of this Sub-Ring.
- In the Module.Port field, enter the ID of the port (in the form X.X) that connects the device to the Sub-Ring (in the example, 1.9). For the connection port, you can use all the available ports that you have not already configured as ring ports of the basis ring.
- You have the option of entering a name for the Sub-Ring (in the example, “Test”).
- Select the Sub-Ring Manager mode (SRM mode). You thus specify which connection between the primary ring and the Sub-Ring becomes the redundant line.

The options for the connection are:

- ▶ Both Sub-Ring Managers have the same setting (default `manager`): - the device with the higher MAC address manages the redundant line.
- ▶ In the SRM Mode field, a device is selected to be the `redundant manager`: - this device manages the redundancy line as long as you have configured the other Sub-Ring Manager as a `manager`, otherwise the higher MAC address applies.

Configure Sub-Ring Manager 1 as the “manager” and Sub-Ring Manager 2 as the manager of the redundant line with “redundant manager”, in accordance with the overview drawing for this example.

Sub Ring ID	Function on/off	Configuration State	Redundancy existing	Module Port	Name	SRM Mode	SRM State	Port-Status	VLAN	Partner MAC
1	<input type="checkbox"/>	<input checked="" type="checkbox"/>	<input checked="" type="checkbox"/>	1.9	Test	manager	manager	0	0	00 00 00 00 00 00

Figure 21: Completely configured Sub-Ring Manager

- Configure the 2nd Sub-Ring Manager in the same way. If you have explicitly assigned SRM 1 the SRM mode `manager`, you configure SRM 2 as `redundant manager`. Otherwise, the assignment is performed automatically via the higher MAC address (see above)
- Switch the two Sub-Ring Managers on under “Function on/off” in the overview of the Sub-Ring dialog.
- Click "Set" to save the changes temporarily.
- Select the dialog
Basic Settings:Load/Save.
- In the “Save” frame, select “To Device” for the location and click “Save” to permanently save the configuration in the active configuration.

```
enable
configure
sub-ring 1 operation enable
Operation set to Enabled
exit
show sub-ring
```

Switch to the privileged EXEC mode.
Switch to the Configuration mode.
Switches on the Sub-Ring with the Sub-Ring ID 1.

Switch to the privileged EXEC mode.
Displays the state for all Sub-Rings on this device.

5 Ring/Network Coupling

Ring/Network Coupling allows the redundant coupling of redundant rings and network segments. Ring/Network Coupling connects 2 rings/network segments via 2 separate paths.

The ring/network coupling supports the coupling of a ring (HIPER-Ring, Fast HIPER-Ring or MRP) to a second ring (also HIPER-Ring, Fast HIPER-Ring or MRP) or to a network segment of any structure, when all the devices in the coupled network are Hirschmann devices.

The ring/network coupling supports the following devices:

- ▶ RS2-./.
- ▶ RS2-16M
- ▶ RS20, RS30, RS40
- ▶ OCTOPUS
- ▶ MICE (from rel. 3.0)
- ▶ PowerMICE
- ▶ MS20, MS30
- ▶ RSR20, RSR30
- ▶ MACH 100
- ▶ MACH 1000
- ▶ MACH 1040
- ▶ MACH 3000 (from Rel. 3.3),
- ▶ MACH 4000

5.1 Variants of the ring/network coupling

The redundant coupling is effected by the **one-Switch coupling** of two ports of **one** device in the first ring/network segment to one port each of two devices in the second ring/network segment (see figure 23). One of the two connections – the redundant one – is blocked for normal data traffic in normal operation.

If the main line no longer functions, the device opens the redundant line immediately. If the main line functions again, the redundant line is again blocked for normal data traffic and the main line is used again.

The ring coupling detects and handles an error within 500 ms (typically 150 ms).

The redundant coupling is effected by the **two-switch coupling** of one port each from **two** devices in the first ring/network segment to one port each of two devices in the second ring/network segment (see figure 29).

The device in the redundant line and the device in the main line use control packets to inform each other about their operating states, via the Ethernet or the control line.

If the main line no longer functions, the redundant device (slave) opens the redundant line immediately. As soon as the main line is working again, the device in the main line informs the redundant device of this. The redundant line is again blocked for normal data traffic and the main line is used again. The ring coupling detects and handles an error within 500 ms (typically 150 ms).

The type of coupling configuration is primarily determined by the topological conditions and the desired level of availability (see table 7).

	One-Switch coupling	Two-Switch coupling	Two-Switch coupling with control line
Application	The 2 devices are in impractical topological positions. Therefore, putting a line between them would involve a lot of effort for two-Switch coupling.	The 2 devices are in practical topological positions. Installing a control line would involve a lot of effort.	The 2 devices are in practical topological positions. Installing a control line would not involve much effort.
Disadvantage	If the Switch configured for the redundant coupling becomes inoperable, no connection remains between the networks.	More effort for connecting the 2 devices to the network (compared with one-Switch coupling).	More effort for connecting the two devices to the network (compared with one-Switch and two-Switch coupling).
Advantage	Less effort involved in connecting the 2 devices to the network (compared with two-Switch coupling).	If one of the devices configured for the redundant coupling becomes inoperable, the coupled networks are still connected.	If one of the devices configured for the redundant coupling becomes inoperable, the coupled networks are still connected.

Table 7: Selection criteria for the configuration types for redundant coupling

Note: Choose a configuration based on topological conditions and the level of availability you require ([see table 7](#)).

5.2 Preparing a Ring/Network Coupling

5.2.1 STAND-BY switch

All devices have a STAND-BY switch, with which you can define the role of the device within a Ring/Network coupling.

Depending on the device type, this switch is a DIP switch on the devices, or else it is exclusively a software setting (`Redundancy:Ring/Network Coupling` dialog). By setting this switch, you define whether the device has the main coupling or the redundant coupling role within a Ring/Network coupling. You will find details on the DIP switches in the “Installation” user manual.

Device type	STAND-BY switch type
RS2-./.	DIP switch
RS2-16M	DIP switch
RS20/RS30/RS40	Selectable: DIP switch and software setting
MICE/Power MICE	Selectable: DIP switch and software setting
MS20/MS30	Selectable: DIP switch and software setting
OCTOPUS	Software switch
RSR20/RSR30	Software switch
MACH 100	Software switch
MACH 1000	Software switch
MACH 3000/MACH 4000	Software switch

Table 8: Overview of the STAND-BY switch types

Depending on the device and model, set the STAND-BY switch in accordance with the following table:

Device with	Choice of main coupling or redundant coupling
DIP switch	On "STAND-BY" DIP switch
DIP switch/software switch option	According to the option selected - on "STAND-BY" DIP switch or in the - Redundancy:Ring/Network Coupling dialog, by making selection in "Select configuration". Note: These devices have a DIP switch, with which you can choose between the software configuration and the DIP switch configuration. You can find details on the DIP switches in the User Manual Installation.
Software switch	In the Redundancy:Ring/Network Coupling dialog

Table 9: Setting the STAND-BY switch

Note: In the following screenshots and diagrams, the following conventions are used:

- ▶ Blue indicates devices or connections of the items currently being described
- ▶ Black indicates devices or connections that connect to the items currently being described
- ▶ Thick lines indicate connections of the items currently being described
- ▶ Thin lines indicate connections which connect to the items currently being described
- ▶ Lines of dashes indicate a redundant connection
- ▶ Dotted lines indicate the control line.

- Select the Redundancy:Ring/Network Coupling dialog.
- You first select the configuration you want: One-Switch coupling ("1"), two-Switch coupling ("2") or two-Switch coupling with control line ("3"), (see figure 22).

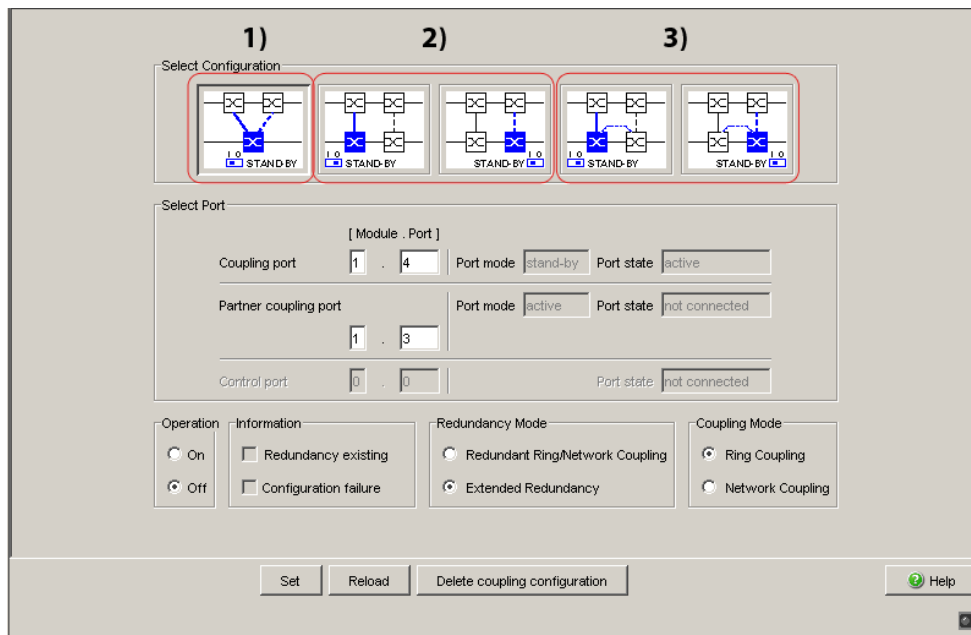

Figure 22: Choosing the ring coupling configuration (when the DIP switch is off, or for devices without a DIP switch)

For devices without DIP switches, the software settings are not restricted.

For devices **with** DIP switches, depending on the DIP switch position, the dialog displays the possible configurations in color, while those configurations that are not possible appear in gray.

The possible configurations are:

- ▶ DIP switch RM: ON or OFF, STAND-BY: OFF:
Two-Switch coupling as master (with or without control line)
- ▶ DIP switch RM: OFF, STAND-BY: ON:
One-Switch coupling and two-Switch coupling as slave (with or without control line)
- ▶ DIP switch RM: ON, STAND-BY: ON:
DIP switches are deactivated, and the software settings are possible without any restrictions

If the DIP switches are activated and you want to use the software to select one of the configurations that are not possible (grayed-out), you put the DIP switches on the device into another position and reload the dialog.

Note: For reasons of redundancy reliability, do not use Rapid Spanning Tree and Ring/Network Coupling in combination.

5.2.2 One-Switch coupling

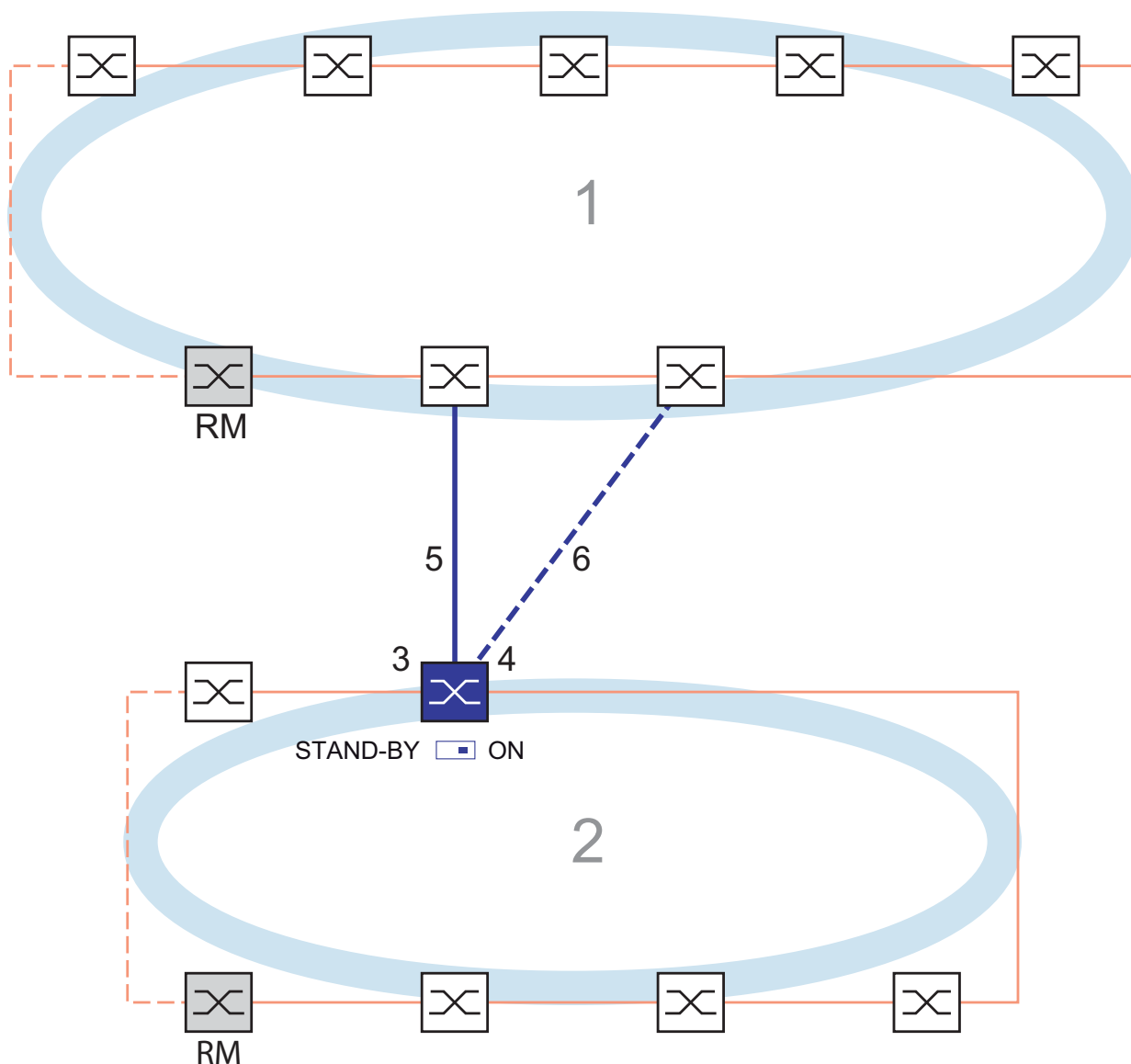

Figure 23: Example of one-Switch coupling

- 1: Backbone
- 2: Ring
- 3: Partner coupling port
- 4: Coupling port
- 5: Main Line
- 6: Redundant Line

The coupling between two networks is performed by the main line (solid blue line) in the normal mode of operation, which is connected to the partner coupling port. If the main line becomes inoperable, the redundant line (dashed blue line), which is connected to the coupling port, takes over the ring/network coupling. The coupling switch-over is performed by **one** Switch.

- Select the `Redundancy:Ring/Network Coupling` dialog.
- Select "One-Switch coupling" by means of the dialog button with the same graphic as below (see figure 24).

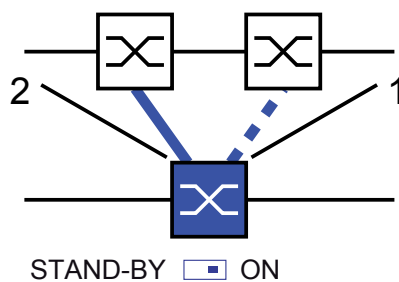

Figure 24: One-Switch-coupling
 1: Coupling port
 2: Partner coupling port

The following settings apply to the Switch displayed in blue in the selected graphic.

- Select the partner coupling port (see figure 25).
 .With "Partner coupling port" you specify at which port you are connecting the control line.
 You will find the port assignment for the redundant coupling in table 10.

The following tables show the selection options and default settings for the ports used in the Ring/Network coupling.

Device	Partner coupling port	Coupling port
RS2-./.	Not possible	Not possible
RS2-16M	All ports (default setting: port 2)	All ports (default setting: port 1)

Table 10: Port assignment for one-Switch coupling

Device	Partner coupling port	Coupling port
RS20, RS30, RS40	All ports (default setting: port 1.3)	All ports (default setting: port 1.4)
OCTOPUS	All ports (default setting: port 1.3)	All ports (default setting: port 1.4)
MICE	All ports (default setting: port 1.3)	All ports (default setting: port 1.4)
PowerMICE	All ports (default setting: port 1.3)	All ports (default setting: port 1.4)
MS20	All ports (default setting: port 1.3)	All ports (default setting: port 1.4)
MS30	All ports (default setting: port 2.3)	All ports (default setting: port 2.4)
RSR20/30	All ports (default setting: port 1.3)	All ports (default setting: port 1.4)
MACH 100	All ports (default setting: port 2.3)	All ports (default setting: port 2.4)
MACH 1000	All ports (default setting: port 1.3)	All ports (default setting: port 1.4)
MACH 3000	All ports	All ports
MACH 4000	All ports (default setting: port 1.3)	All ports (default setting: port 1.4)

Table 10: Port assignment for one-Switch coupling

Note: Configure the partner coupling port and the ring redundancy ports on different ports.

- Select the coupling port (see figure 25).

With “Coupling port” you specify at which port you are connecting the network segments:

You will find the port assignment for the redundant coupling in table 10.

Note: Configure the coupling port and the redundancy ring ports on different ports.

- Activate the function in the “Operation” frame (see figure 25)
- Now connect the redundant line.

The displays in the “Select port” frame mean:

- “Port mode”: The port is either active or in stand-by mode.
- “Port state”: The port is either active, in stand-by mode or not connected.

The displays in the “Information” frame mean:

- “Redundancy guaranteed”: If the main line no longer functions, the redundant line takes over the function of the main line.
- “Configuration failure”: The function is incomplete or incorrectly configured.

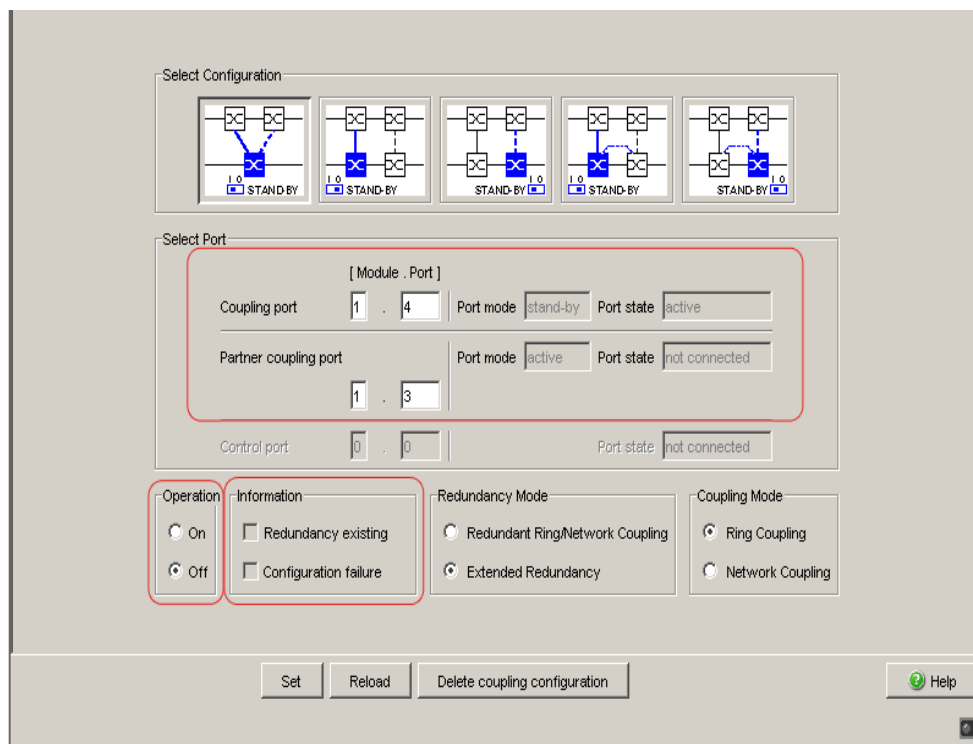

Figure 25: One-Switch coupling: Selecting the port and enabling/disabling operation

Note: The following settings are required for the coupling ports (you select the Basic Settings:Port Configuration dialog):
[See table 3 on page 30.](#)

Note: If VLANs are configured, set the coupling and partner coupling ports' VLAN configuration as follows:

- in the dialog `Switching:VLAN:Port` Port VLAN ID 1 and „Ingress Filtering“ deactivated
- in the dialog `Switching:VLAN:Static VLAN-Membership U` (Untagged)

Redundancy mode

- In the “Redundancy Mode” frame, select (see figure 26)
 - “Redundant Ring/Network Coupling” or
 - “Extended Redundancy”.

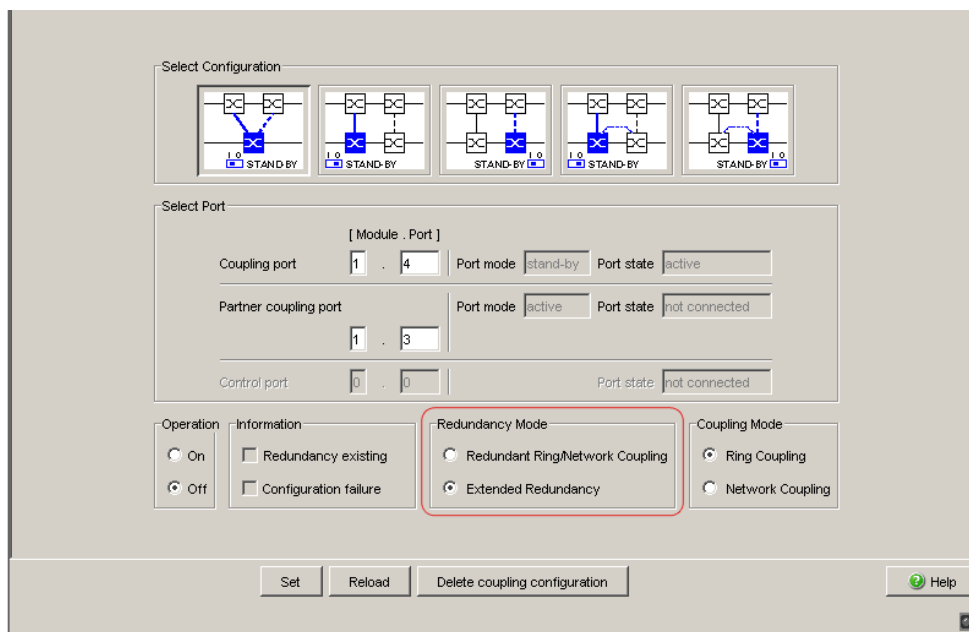

Figure 26: One-Switch coupling: Selecting the redundancy mode

With the “Redundant Ring/Network Coupling” setting, either the main line or the redundant line is active. The lines are never both active at the same time.

With the “Extended Redundancy” setting, the main line and the redundant line are simultaneously active if the connection line between the devices in the connected (i.e., remote) network becomes inoperable (see figure 27). During the reconfiguration period, packet duplications may occur. Therefore, select this setting only if your application detects package duplications.

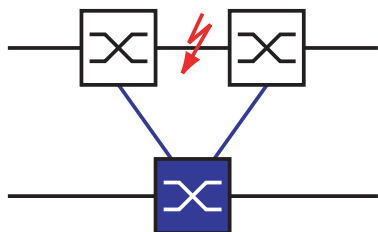

Figure 27: Extended redundancy

Coupling mode

The coupling mode indicates the type of the connected network.

- In the “Coupling Mode” frame, select (see figure 28)
 - “Ring Coupling” or
 - “Network Coupling”

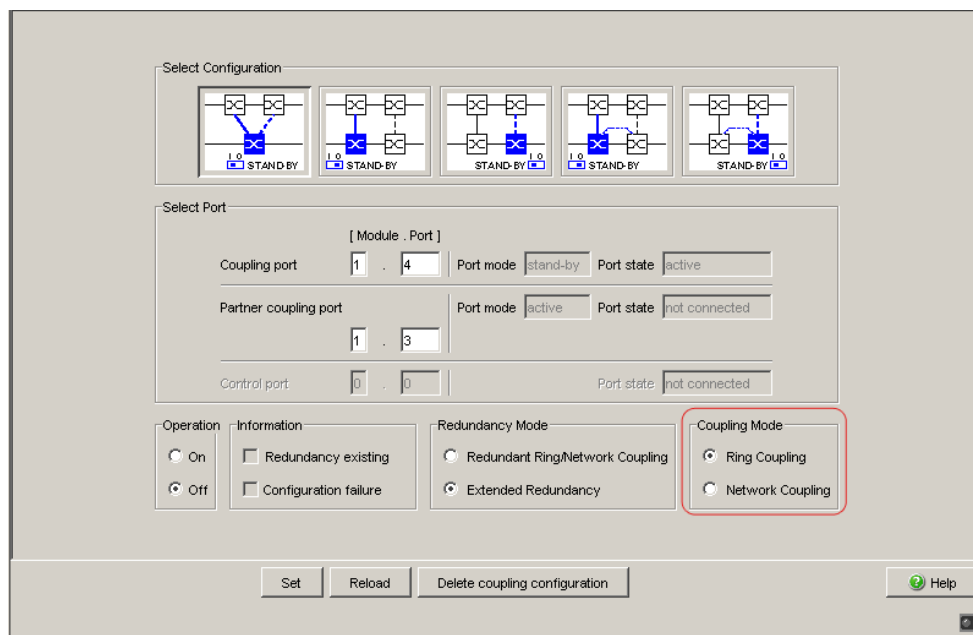

Figure 28: One-Switch coupling: Selecting the coupling mode

- Select **"Ring coupling"** if you are connecting to a redundancy ring.
- Select **"Network Coupling"** if you are connecting to a line or tree structure.

Delete coupling configuration

- The "Delete coupling configuration" button in the dialog allows you to reset all the coupling settings of the device to the state on delivery.

5.2.3 Two-Switch coupling

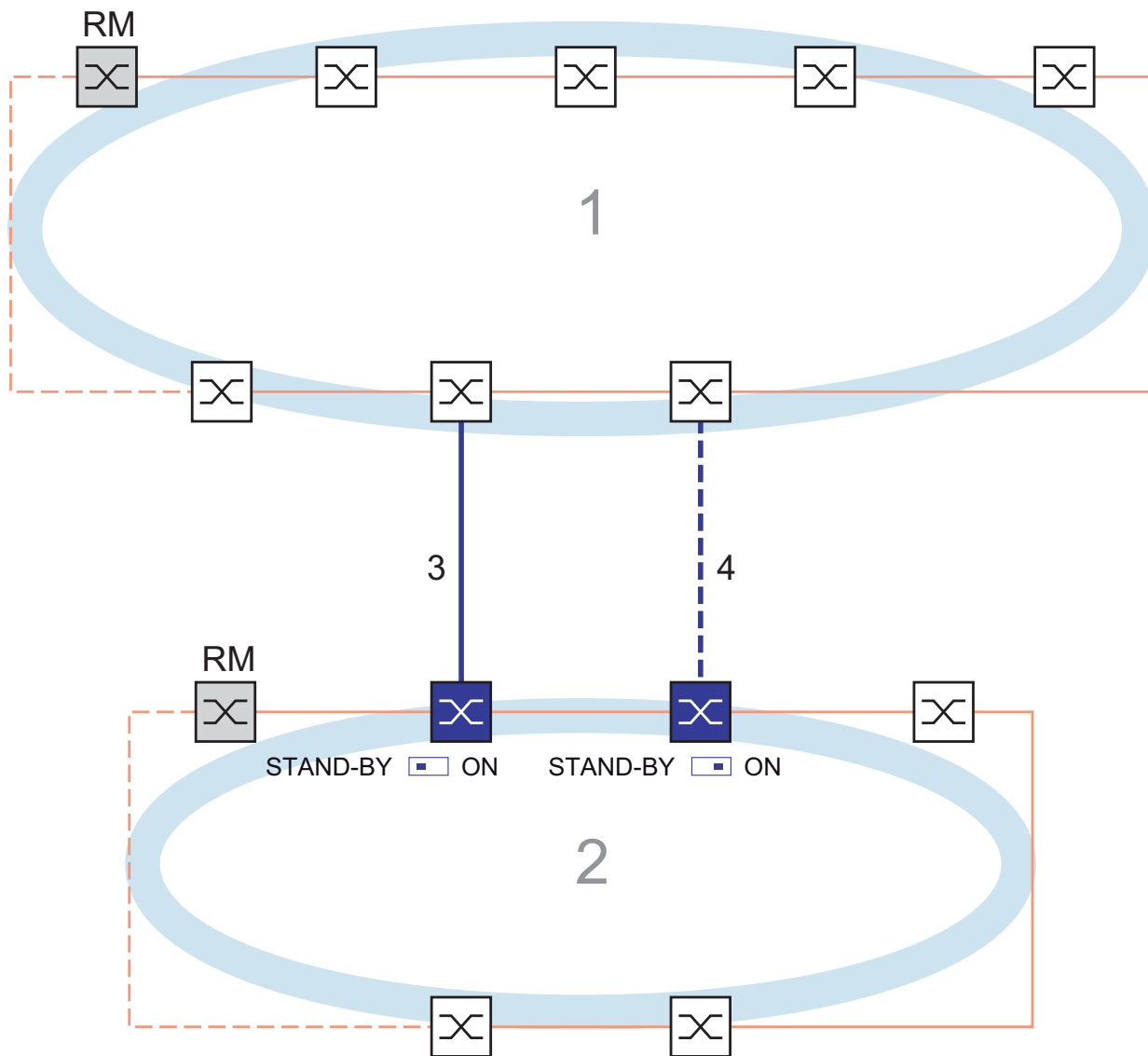

Figure 29: Example of two-Switch coupling

- 1: Backbone
- 2: Ring
- 3: Main line
- 4: Redundant line

The coupling between 2 networks is performed by the main line (solid blue line). If the main line or one of the adjacent Switches becomes inoperable, the redundant line (dashed black line) takes over coupling the 2 networks. The coupling is performed by two Switches.

The switches send their control packages over the Ethernet.

The Switch connected to the main line, and the Switch connected to the redundant line are partners with regard to the coupling.

- Connect the two partners via their ring ports.

- Select the `Redundancy:Ring/Network Coupling` dialog.
- Select "Two-Switch coupling" by means of the dialog button with the same graphic as below (see figure 30).

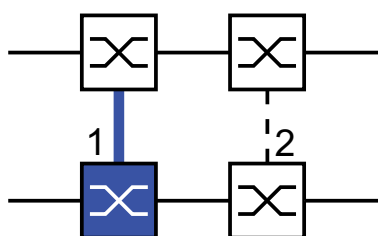

STAND-BY ON

Figure 30: Two-Switch coupling
 1: Coupling port
 2: Partner coupling port

The following settings apply to the Switch displayed in blue in the selected graphic.

- Select the coupling port (see figure 31).
 With "Coupling port" you specify at which port you are connecting the network segments:
 You will find the port assignment for the redundant coupling in table 11.
- For a device with DIP switches, you switch the STAND-BY switch to OFF or deactivate the DIP switches. Connect the main line to the coupling port.

Device	Coupling port
RS2-./.	Not possible
RS2-16M	Adjustable for all ports (default setting: port 1)
RS20, RS30, RS40	Adjustable for all ports (default setting: port 1.4)
OCTOPUS	Adjustable for all ports (default setting: port 1.4)
MICE	Adjustable for all ports (default setting: port 1.4)
PowerMICE	Adjustable for all ports (default setting: port 1.4)
MS20	Adjustable for all ports (default setting: port 1.4)
MS30	Adjustable for all ports (default setting: port 2.4)
RSR20/30	Adjustable for all ports (default setting: port 1.4)
MACH 100	Adjustable for all ports (default setting: port 2.4)
MACH 1000	Adjustable for all ports (default setting: port 1.4)
MACH 3000	Adjustable for all ports
MACH 4000	Adjustable for all ports (default setting: port 1.4)

Table 11: Port assignment for the redundant coupling (two-Switch coupling)

Note: Configure the coupling port and the redundancy ring ports on different ports.

- Activate the function in the “Operation” frame ([see figure 31](#))
- Now connect the redundant line.

The displays in the “Select port” frame mean:

- “Port mode”: The port is either active or in stand-by mode.
- “Port state”: The port is either active, in stand-by mode or not connected.
- “IP Address”: The IP address of the partner, if the partner is already operating in the network.

The displays in the “Information” frame mean:

- “Redundancy guaranteed”: If the main line no longer functions, the redundant line takes over the function of the main line.
- “Configuration failure”: The function is incomplete or incorrectly configured.

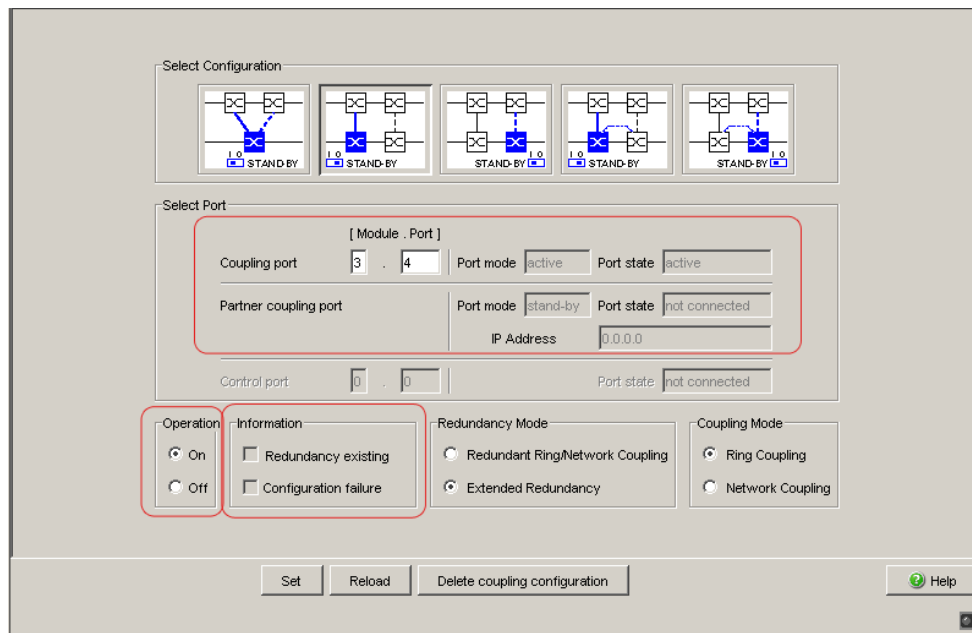

Figure 31: Two-Switch coupling: Selecting the port and enabling/disabling operation

To avoid continuous loops, the Switch sets the port state of the coupling port to “off” if you:

- switch off the operation setting or
- change the configuration

while the connections are in operation at these ports.

Note: The following settings are required for the coupling ports (you select the `Basic Settings:Port Configuration` dialog):

See table 3 on page 30.

Note: If VLANs are configured, set the coupling and partner coupling ports’ VLAN configuration as follows:

- in the dialog `Switching:VLAN:Port` Port VLAN ID 1 and „Ingress Filtering“ deactivated
- in the dialog `Switching:VLAN:Static VLAN-Membership U` (Untagged)

Note: If you are operating the Ring Manager and two-Switch coupling functions at the same time, there is the possibility of creating a loop.

- Select "Two-Switch coupling" by means of the dialog button with the same graphic as below (see figure 32).

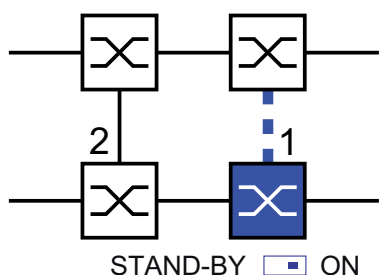

Figure 32: Two-Switch coupling

1: Coupling port

2: Partner coupling port

The following settings apply to the Switch displayed in blue in the selected graphic.

- Select the coupling port (see figure 31).
With "Coupling port" you specify at which port you are connecting the network segments:
You will find the port assignment for the redundant coupling in table 11.
- For a device with DIP switches, you switch the STAND-BY switch to ON or deactivate the DIP switches. You connect the redundant line to the coupling port.

Note: Configure the coupling port and the redundancy ring ports on different ports.

- Activate the function in the "Operation" frame (see figure 31)

The displays in the "Select port" frame mean:

- "Port mode": The port is either active or in stand-by mode.
- "Port state": The port is either active, in stand-by mode or not connected.
- "IP Address": The IP address of the partner, if the partner is already operating in the network.

The displays in the “Information” frame mean:

- “Redundancy guaranteed”: If the main line no longer functions, the redundant line takes over the function of the main line.
- “Configuration failure”: The function is incomplete or incorrectly configured.

To avoid continuous loops, the Switch sets the port state of the coupling port to “off” if you::

- switch off operation or
- change the configuration

while the connections are in operation at these ports.

Note: The following settings are required for the coupling ports (you select the `Basic Settings:Port Configuration` dialog):

[See table 3 on page 30.](#)

Note: If VLANs are configured, set the coupling and partner coupling ports’ VLAN configuration as follows:

- in the dialog `Switching:VLAN:Port` Port VLAN ID 1 and „Ingress Filtering“ deactivated
- in the dialog `Switching:VLAN:Static` VLAN-Membership U (Untagged)

Note: If you are operating the Ring Manager and two-Switch coupling functions at the same time, there is the possibility of creating a loop.

Redundancy mode

- In the “Redundancy Mode” frame, select ([see figure 33](#))
 - “Redundant Ring/Network Coupling” or
 - “Extended Redundancy”.

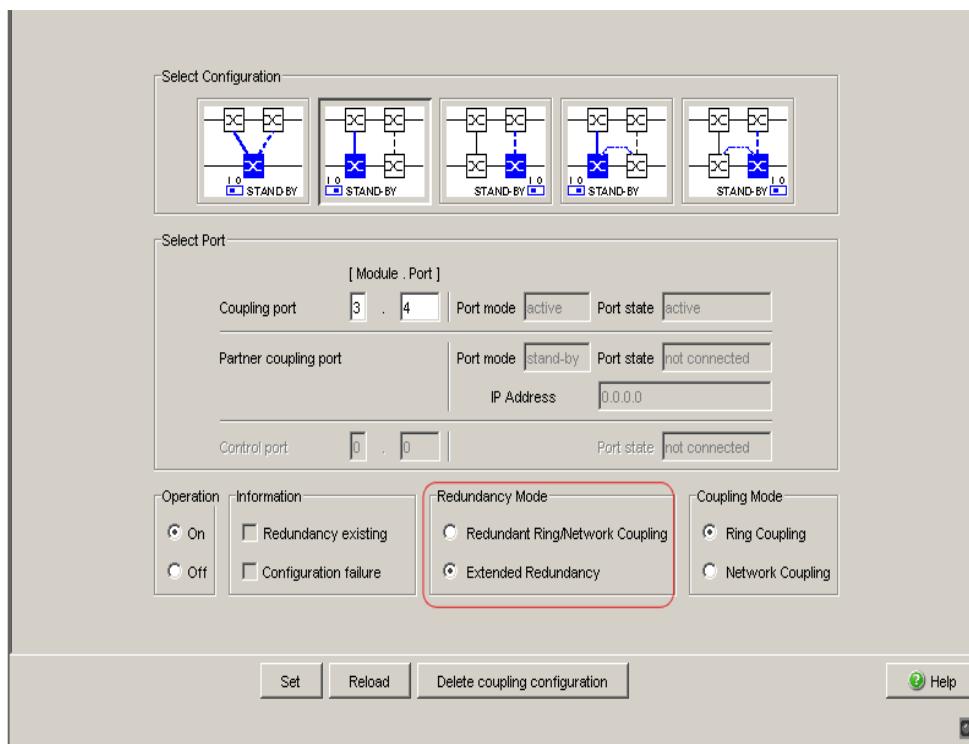

Figure 33: Two-Switch coupling: Selecting the redundancy mode

With the “Redundant Ring/Network Coupling” setting, either the main line or the redundant line is active. The lines are never both active at the same time.

With the “Extended Redundancy” setting, the main line and the redundant line are simultaneously active if the connection line between the devices in the connected (i.e. remote) network fails (see figure 27). During the reconfiguration period, package duplications may occur. Therefore, only select this setting if your application detects package duplications.

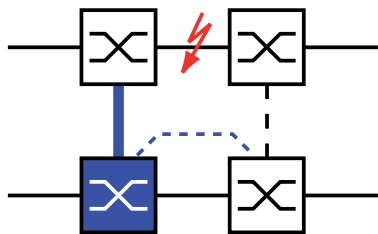

Figure 34: Extended redundancy

Coupling mode

The coupling mode indicates the type of the connected network.

- In the “Coupling Mode” frame, select (see figure 35)
 - “Ring Coupling” or
 - “Network Coupling”

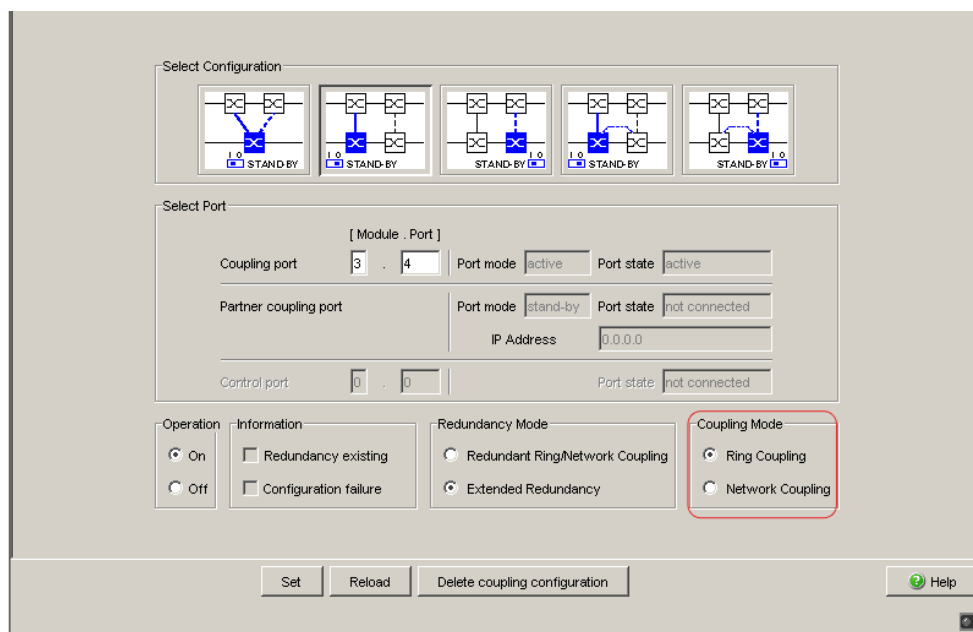

Figure 35: Two-Switch coupling: Selecting the coupling mode

- Select **"Ring coupling"** if you are connecting to a redundancy ring.
- Select **"Network Coupling"** if you are connecting to a line or tree structure.

Delete coupling configuration

- The “Delete coupling configuration” button in the dialog allows you to reset all the coupling settings of the device to the state on delivery.

5.2.4 Two-Switch Coupling with Control Line

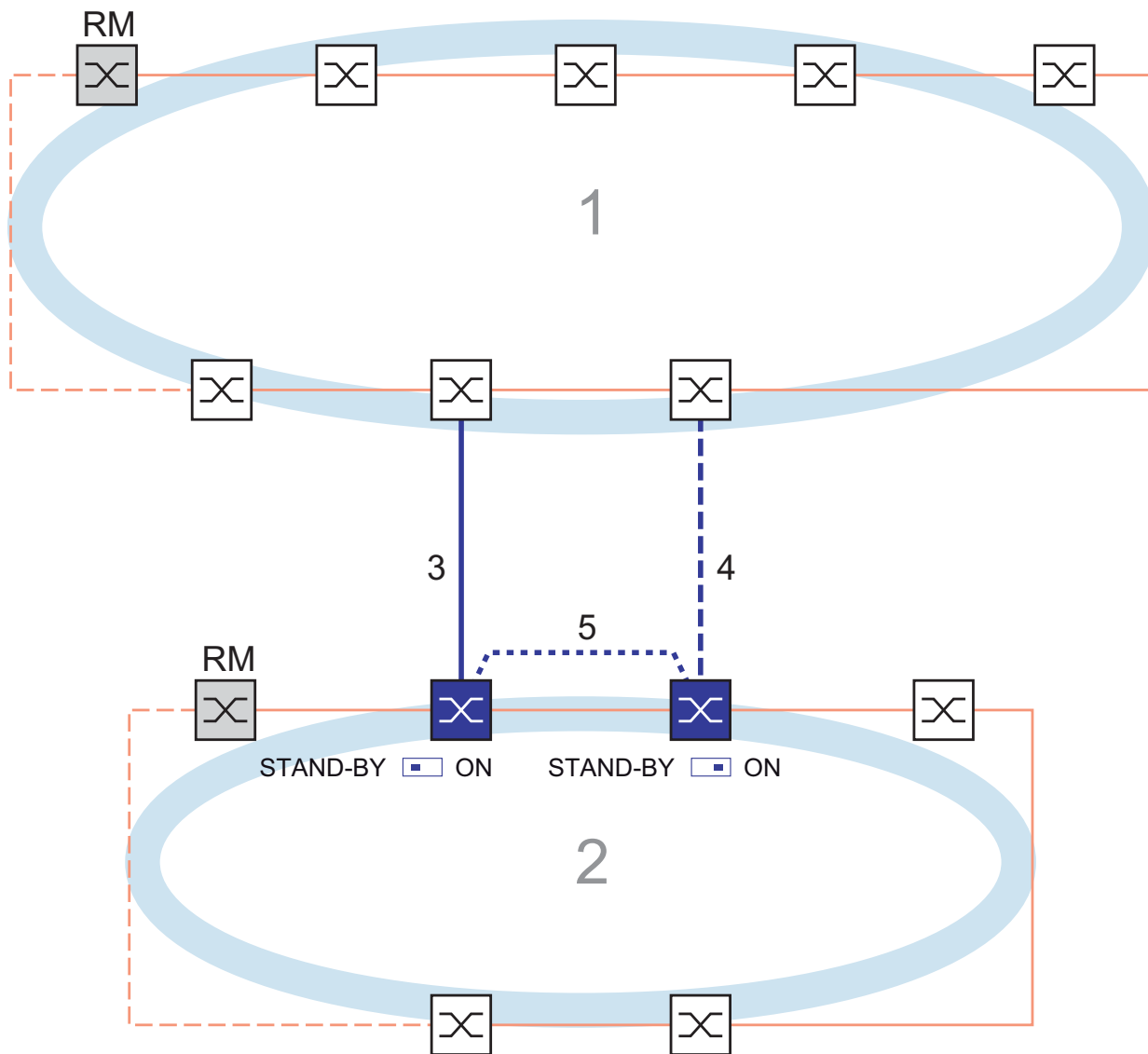

Figure 36: Example of Two-Switch coupling with control line

- 1: Backbone
- 2: Ring
- 3: Main line
- 4: Redundant line
- 5: Control line

The coupling between 2 networks is performed by the main line (solid blue line). If the main line or one of the adjacent Switches becomes inoperable, the redundant line (dashed black line) takes over coupling the 2 networks. The coupling is performed by two Switches.

The Switches send their control packets over a control line (dotted line). The Switch connected to the main line, and the Switch connected to the redundant line are partners with regard to the coupling.

- Connect the two partners via their ring ports.

- Select the `Redundancy:Ring/Network Coupling` dialog.
- Select „Two-Switch coupling with control line“ by means of the dialog button with the same graphic as below (see figure 37).

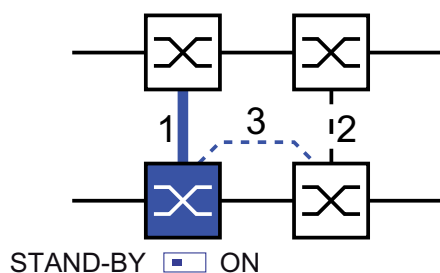

Figure 37: Two-Switch coupling with control line

- 1: Coupling port
- 2: Partner coupling port
- 3: Control line

The following settings apply to the Switch displayed in blue in the selected graphic.

- Select the coupling port (see figure 38).
With “Coupling port” you specify at which port you are connecting the network segments:
You will find the port assignment for the redundant coupling in table 12.
- For a device with DIP switches, you switch the STAND-BY switch to OFF or deactivate the DIP switches. Connect the main line to the coupling port.

- Select the control port (see figure 38)

With “Control port” you specify at which port you are connecting the control line.

You will find the port assignment for the redundant coupling in table 12.

Device	Coupling port	Control port
RS2-./.	Port 1	Stand-by port (can only be combined with RS2-../..)
RS2-16M	Adjustable for all ports (default setting: port 1)	Adjustable for all ports (default setting: port 2)
RS20, RS30, RS40	Adjustable for all ports (default setting: port 1.4)	Adjustable for all ports (default setting: port 1.3)
OCTOPUS	Adjustable for all ports (default setting: port 1.4)	Adjustable for all ports (default setting: port 1.3)
MICE	Adjustable for all ports (default setting: port 1.4)	Adjustable for all ports (default setting: port 1.3)
PowerMICE	Adjustable for all ports (default setting: port 1.4)	Adjustable for all ports (default setting: port 1.3)
MS20	Adjustable for all ports (default setting: port 1.4)	Adjustable for all ports (default setting: port 1.3)
MS30	Adjustable for all ports (default setting: port 2.4)	Adjustable for all ports (default setting: port 2.3)
RSR20/RSR30	Adjustable for all ports (default setting: port 1.4)	Adjustable for all ports (default setting: port 1.3)
MACH 100	Adjustable for all ports (default setting: port 2.4)	Adjustable for all ports (default setting: port 2.3)
MACH 1000	Adjustable for all ports (default setting: port 1.4)	Adjustable for all ports (default setting: port 1.3)
MACH 3000	Adjustable for all ports	Adjustable for all ports
MACH 4000	Adjustable for all ports (default setting: port 1.4)	Adjustable for all ports (default setting: port 1.3)

Table 12: Port assignment for the redundant coupling (two-Switch coupling with control line)

Note: Configure the coupling port and the redundancy ring ports on different ports.

- Activate the function in the “Operation” frame (see figure 38)
- Now connect the redundant line and the control line.

The displays in the “Select port” frame mean:

- “Port mode”: The port is either active or in stand-by mode.
- “Port state”: The port is either active, in stand-by mode or not connected.
- “IP Address”: The IP address of the partner, if the partner is already operating in the network.

The displays in the “Information” frame mean:

- “Redundancy guaranteed”: If the main line no longer functions, the redundant line takes over the function of the main line.
- “Configuration failure”: The function is incomplete or incorrectly configured.

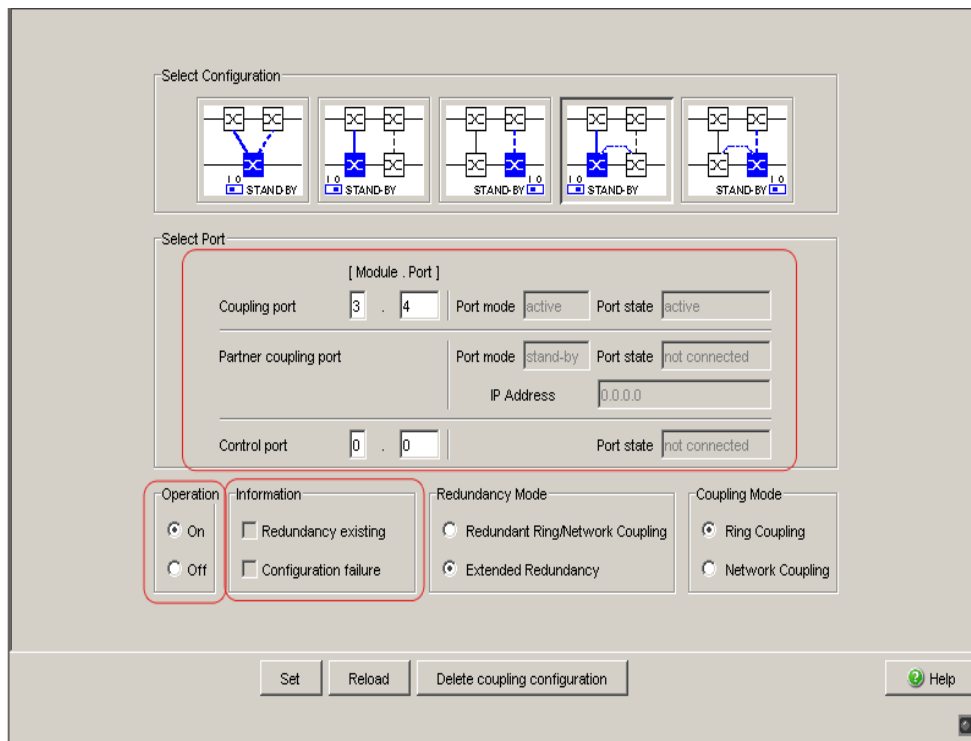

Figure 38: Two-Switch coupling with control line: Selecting the port and enabling/disabling operation

To avoid continuous loops, the Switch sets the port state of the coupling port to “off” if you:

- switch off the operation setting or
- change the configuration

while the connections are in operation at these ports.

Note: The following settings are required for the coupling ports (you select the `Basic Settings:Port Configuration` dialog):
See [table 3 on page 30](#).

Note: If VLANs are configured, set the coupling and partner coupling ports' VLAN configuration as follows:

- in the dialog `Switching:VLAN:Port Port VLAN ID 1` and „Ingress Filtering“ deactivated
- in the dialog `Switching:VLAN:Static VLAN-Membership U (Untagged)`

- Select "Two-Switch coupling with control line" by means of the dialog button with the same graphic as below ([see figure 39](#)).

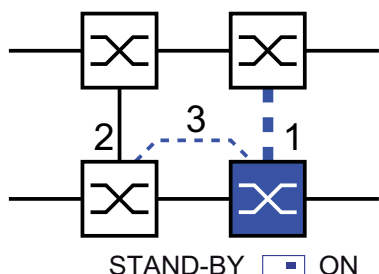

Figure 39: Two-Switch coupling with control line

- 1: Coupling port
- 2: Partner coupling port
- 3: Control line

The following settings apply to the Switch displayed in blue in the selected graphic.

- Select the coupling port ([see figure 38](#)).
With "Coupling port" you specify at which port you are connecting the network segments:
You will find the port assignment for the redundant coupling in [table 12](#).
- For a device with DIP switches, you switch the STAND-BY switch to ON or deactivate the DIP switches. You connect the redundant line to the coupling port.
- Select the control port ([see figure 38](#))
With "Control port" you specify at which port you are connecting the control line.

Note: Configure the coupling port and the redundancy ring ports on different ports.

- Activate the function in the “Operation” frame (see figure 38)
- Now connect the redundant line and the control line.

The displays in the “Select port” frame mean:

- “Port mode”: The port is either active or in stand-by mode.
- “Port state”: The port is either active, in stand-by mode or not connected.
- “IP Address”: The IP address of the partner, if the partner is already operating in the network.

The displays in the “Information” frame mean:

- “Redundancy guaranteed”: If the main line no longer functions, the redundant line takes over the function of the main line.
- “Configuration failure”: The function is incomplete or incorrectly configured.

To avoid continuous loops, the Switch sets the port state of the coupling port to “off” if you:

- switch off the operation setting or
- change the configuration

while the connections are in operation at these ports.

Note: The following settings are required for the coupling ports (you select the `Basic Settings:Port Configuration` dialog):

- Port: on
- Automatic configuration (autonegotiation):
on for twisted-pair connections
- Manual configuration: 100 Mbit/s FDX, 1 Gbit/s FDX, or 10 Gbit/s FDX, according to the port’s capabilities
for glass fiber connections

Note: If VLANs are configured, set the coupling and partner coupling ports’ VLAN configuration as follows:

- in the dialog `Switching:VLAN:Port` Port VLAN ID 1 and „Ingress Filtering“ deactivated
- in the dialog `Switching:VLAN:Static` VLAN-Membership U (Untagged)

Redundancy mode

- In the “Redundancy Mode” frame, select:
 - “Redundant Ring/Network Coupling”
 - or
 - “Extended Redundancy”.

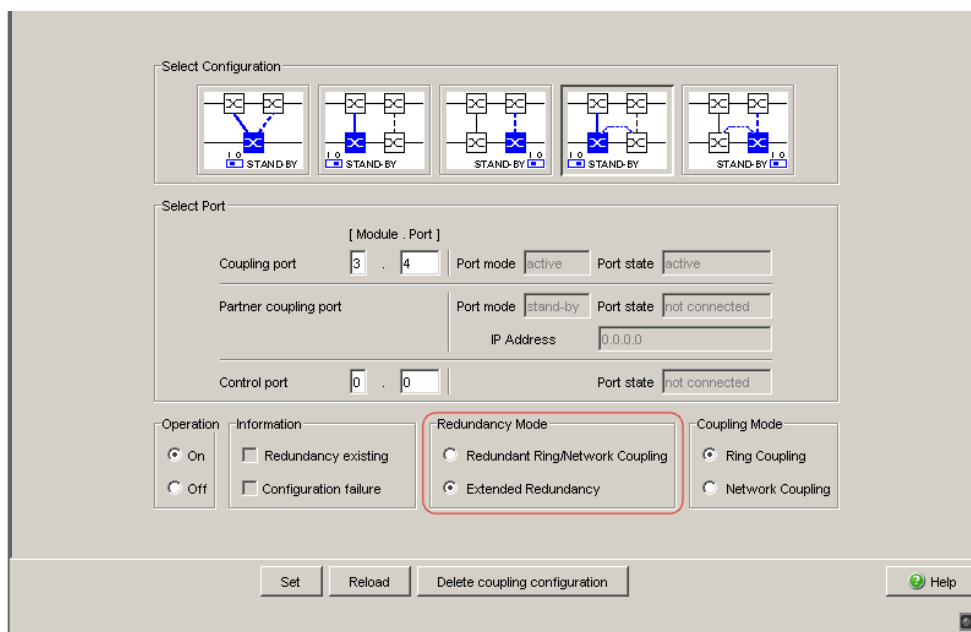

Figure 40: Two-Switch coupling with control line: Selecting the redundancy mode

With the “Redundant Ring/Network Coupling” setting, either the main line or the redundant line is active. The lines are never both active at the same time.

With the “Extended Redundancy” setting, the main line and the redundant line are simultaneously active if the connection line between the devices in the connected (i.e. remote) network fails (see figure 27). During the reconfiguration period, package duplications may occur. Therefore, only select this setting if your application detects package duplications.

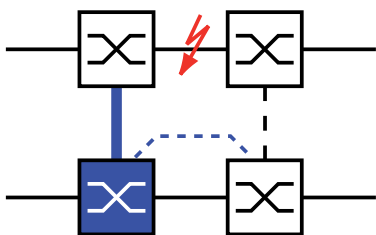

Figure 41: Extended redundancy

Coupling mode

The coupling mode indicates the type of the connected network.

- In the “Coupling Mode” frame, select:
 - “Ring coupling”
 - or
 - “Network Coupling”

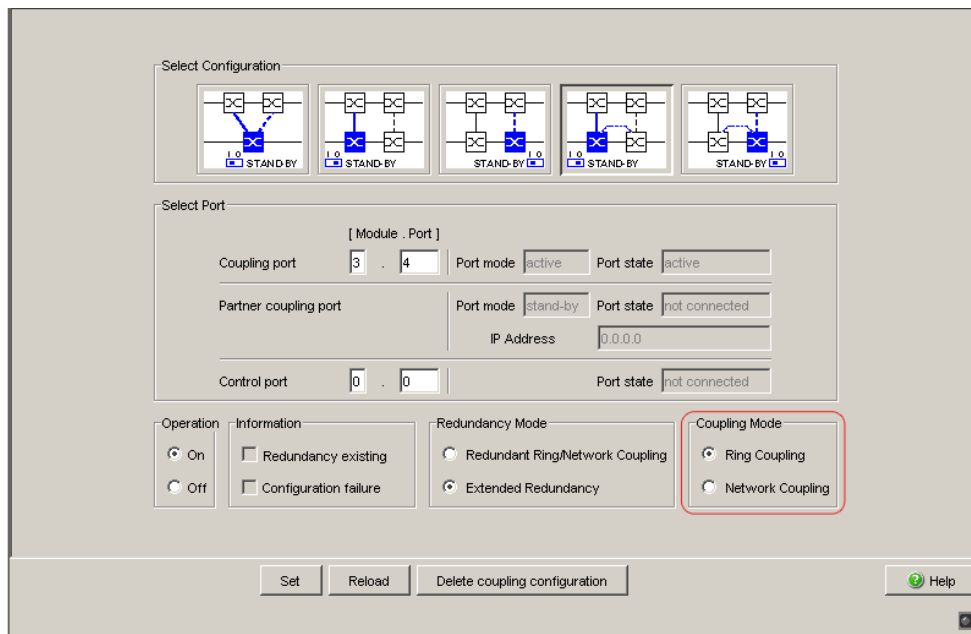

Figure 42: Two-Switch coupling with control line: Selecting the coupling mode

- Select **"Ring coupling"** if you are connecting to a redundancy ring.
- Select **"Network Coupling"** if you are connecting to a line or tree structure.

Delete coupling configuration

- The “Delete coupling configuration” button in the dialog allows you to reset all the coupling settings of the device to the state on delivery.

6 Spanning Tree

Note: The Spanning Tree Protocol is a protocol for MAC bridges. For this reason, the following description uses the term bridge for Switch.

Local networks are getting bigger and bigger. This applies to both the geographical expansion and the number of network participants. Therefore, it is advantageous to use multiple bridges, for example:

- ▶ to reduce the network load in sub-areas,
- ▶ to set up redundant connections and
- ▶ to overcome distance limitations.

However, using multiple bridges with multiple redundant connections between the subnetworks can lead to loops and thus loss of communication across of the network. In order to help avoid this, you can use Spanning Tree. Spanning Tree enables loop-free switching through the systematic deactivation of redundant connections. Redundancy enables the systematic reactivation of individual connections as needed.

RSTP is a further development of the Spanning Tree Protocol (STP) and is compatible with it. If a connection or a bridge becomes inoperable, the STP required a maximum of 30 seconds to reconfigure. This is no longer acceptable in time-sensitive applications. RSTP achieves average reconfiguration times of less than a second. When you use RSTP in a ring topology with 10 to 20 devices, you can even achieve reconfiguration times in the order of milliseconds.

Note: RSTP reduces a layer 2 network topology with redundant paths into a tree structure (Spanning Tree) that does not contain any more redundant paths. One of the Switches takes over the role of the root bridge here. The maximum number of devices permitted in an active branch (from the root bridge to the tip of the branch) is specified by the variable `Max Age` for the current root bridge. The preset value for `Max Age` is 20, which can be increased up to 40.

If the device working as the root is inoperable and another device takes over its function, the `Max Age` setting of the new root bridge determines the maximum number of devices allowed in a branch.

Note: The RSTP standard dictates that all the devices within a network work with the (Rapid) Spanning Tree Algorithm. If STP and RSTP are used at the same time, the advantages of faster reconfiguration with RSTP are lost in the network segments that are operated in combination.

A device that only supports RSTP works together with MSTP devices by not assigning an MST region to itself, but rather the CST (Common Spanning Tree).

Note: By changing the IEEE 802.1D-2004 standard for RSTP, the Standards Commission reduced the maximum value for the “Hello Time” from 10 s to 2 s. When you update the Switch software from a release before 5.0 to release 5.0 or higher, the new software release automatically reduces the locally entered “Hello Time” values that are greater than 2 s to 2 s. If the device is not the RSTP root, “Hello Time” values greater than 2 s can remain valid, depending on the software release of the root device.

6.1 The Spanning Tree Protocol

Because RSTP is a further development of the STP, all the following descriptions of the STP also apply to the RSTP.

6.1.1 The tasks of the STP

The Spanning Tree Algorithm reduces network topologies built with bridges and containing ring structures due to redundant links to a tree structure. In doing so, STP opens ring structures according to preset rules by deactivating redundant paths. If a path is interrupted because a network component becomes inoperable, STP reactivates the previously deactivated path again. This allows redundant links to increase the availability of communication. STP determines a bridge that represents the STP tree structure's base. This bridge is called root bridge.

Features of the STP algorithm:

- ▶ automatic reconfiguration of the tree structure in the case of a bridge becoming inoperable or the interruption of a data path
- ▶ the tree structure is stabilized up to the maximum network size (up to 39 hops, depending on the setting for `Max Age`, [\(see table 15\)](#))
- ▶ stabilization of the topology within a short time period
- ▶ topology can be specified and reproduced by the administrator
- ▶ transparency for the terminal devices
- ▶ low network load relative to the available transmission capacity due to the tree structure created

6.1.2 Bridge parameters

In the context of Spanning Tree, each bridge and its connections are uniquely described by the following parameters:

- ▶ Bridge Identifier
- ▶ Root Path Cost for the bridge ports,
- ▶ Port Identifier

6.1.3 Bridge Identifier

The Bridge Identifier consists of 8 bytes. The 2 highest-value bytes are the priority. The default setting for the priority number is 32,768, but the Management Administrator can change this when configuring the network. The 6 lowest-value bytes of the bridge identifier are the bridge's MAC address. The MAC address allows each bridge to have unique bridge identifiers.

The bridge with the smallest number for the bridge identifier has the highest priority.



Figure 43: Bridge Identifier, Example (values in hexadecimal notation)

6.1.4 Root Path Cost

Each path that connects 2 bridges is assigned a cost for the transmission (path cost). The Switch determines this value based on the transmission speed (see table 13). It assigns a higher path cost to paths with lower transmission speeds.

Alternatively, the Administrator can set the path cost. Like the Switch, the Administrator assigns a higher path cost to paths with lower transmission speeds. However, since the Administrator can choose this value freely, he has a tool with which he can give a certain path an advantage among redundant paths.

The root path cost is the sum of all individual costs of those paths that a data packet has to traverse from a connected bridge's port to the root bridge.

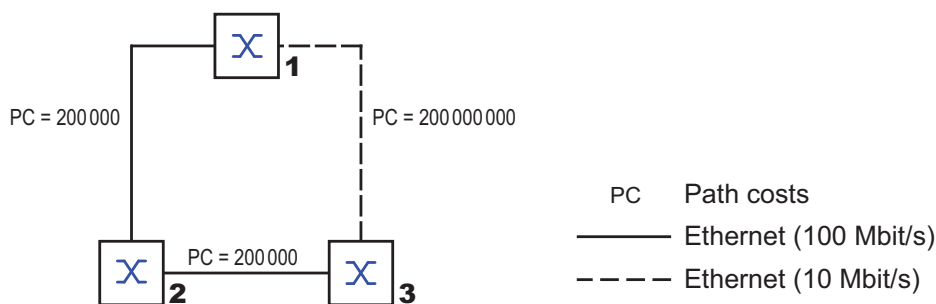

Figure 44: Path costs

Data rate	Recommended value	Recommended range	Possible range
≤100 Kbit/s	200,000,000 ^a	20,000,000-200,000,000	1-200,000,000
1 Mbit/s	20,000,000 ^a	2,000,000-200,000,000	1-200,000,000
10 Mbit/s	2,000,000 ^a	200,000-20,000,000	1-200,000,000
100 Mbit/s	200,000 ^a	20,000-2,000,000	1-200,000,000
1 Gbit/s	20,000	2,000-200,000	1-200,000,000
10 Gbit/s	2,000	200-20,000	1-200,000,000
100 Gbit/s	200	20-2,000	1-200,000,000
1 TBit/s	20	2-200	1-200,000,000
10 TBit/s	2	1-20	1-200,000,000

Table 13: Recommended path costs for RSTP based on the data rate.

- a. Bridges that conform with IEEE 802.1D 1998 and only support 16-bit values for the path costs should use the value 65,535 (FFFFH) for path costs when they are used in conjunction with bridges that support 32-bit values for the path costs.

Note: If link aggregation ([see on page 15 “Link Aggregation”](#)) is used to combine the connection lines between devices into a trunk, then the automatically specified path costs are reduced by half.

6.1.5 Port Identifier

The port identifier consists of 2 bytes. One part, the lower-value byte, contains the physical port number. This provides a unique identifier for the port of this bridge. The second, higher-value part is the port priority, which is specified by the Administrator (default value: 128). It also applies here that the port with the smallest number for the port identifier has the highest priority.

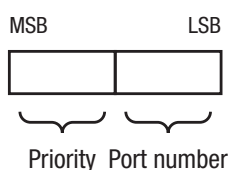

Figure 45: Port Identifier

6.2 Rules for Creating the Tree Structure

6.2.1 Bridge information

To determine the tree structure, the bridges need more detailed information about the other bridges located in the network.

To obtain this information, each bridge sends a BPDU (Bridge Protocol Data Unit) to the other bridges.

The contents of a BPDU include

- ▶ bridge identifier,
- ▶ root path costs and
- ▶ port identifier

(see IEEE 802.1D).

6.2.2 Setting up the tree structure

- ▶ The bridge with the smallest number for the bridge identifier is called the root bridge. It is (or will become) the root of the tree structure.
- ▶ The structure of the tree depends on the root path costs. Spanning Tree selects the structure so that the path costs between each individual bridge and the root bridge become as small as possible.

- ▶ If there are multiple paths with the same root path costs, the bridge further away from the root decides which port it blocks. For this purpose, it uses the bridge identifiers of the bridge closer to the root. The bridge blocks the port that leads to the bridge with the numerically higher ID (a numerically higher ID is the logically worse one). If 2 bridges have the same priority, the bridge with the numerically larger MAC address has the numerically higher ID, which is logically the worse one.
- ▶ If multiple paths with the same root path costs lead from one bridge to the same bridge, the bridge further away from the root uses the port identifier of the other bridge as the last criterion ([see figure 45](#)). In the process, the bridge blocks the port that leads to the port with the numerically higher ID (a numerically higher ID is the logically worse one). If 2 ports have the same priority, the port with the higher port number has the numerically higher ID, which is logically the worse one.

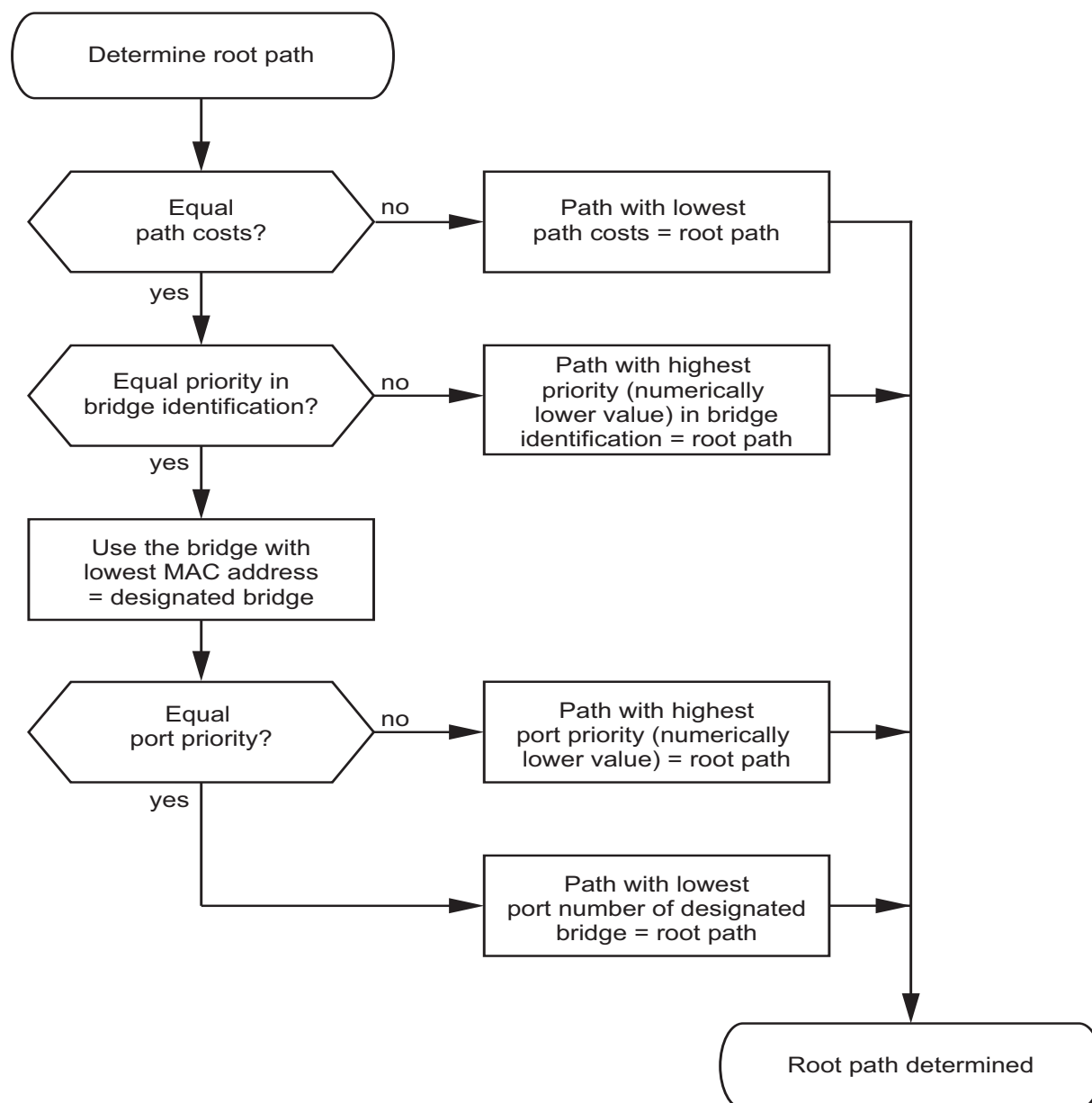

Figure 46: Flow diagram for specifying the root path

6.3 Example of determining the root path

You can use the network plan (see figure 47) to follow the flow chart (see figure 46) for determining the root path. The administrator has specified a priority in the bridge identification for each bridge. The bridge with the smallest numerical value for the bridge identification takes on the role of the root bridge, in this case, bridge 1. In the example all the sub-paths have the same path costs. The protocol blocks the path between bridge 2 and bridge 3 as a connection from bridge 3 via bridge 2 to the root bridge would result in higher path costs.

The path from bridge 6 to the root bridge is interesting:

- ▶ The path via bridge 5 and bridge 3 creates the same root path costs as the path via bridge 4 and bridge 2.
- ▶ The bridges select the path via bridge 5 because the value 28,672 for the priority in the bridge identifier is smaller than value 32,768.
- ▶ There are also 2 paths between bridge 6 and bridge 4. The port identifier is decisive here (Port 1 < Port 3).

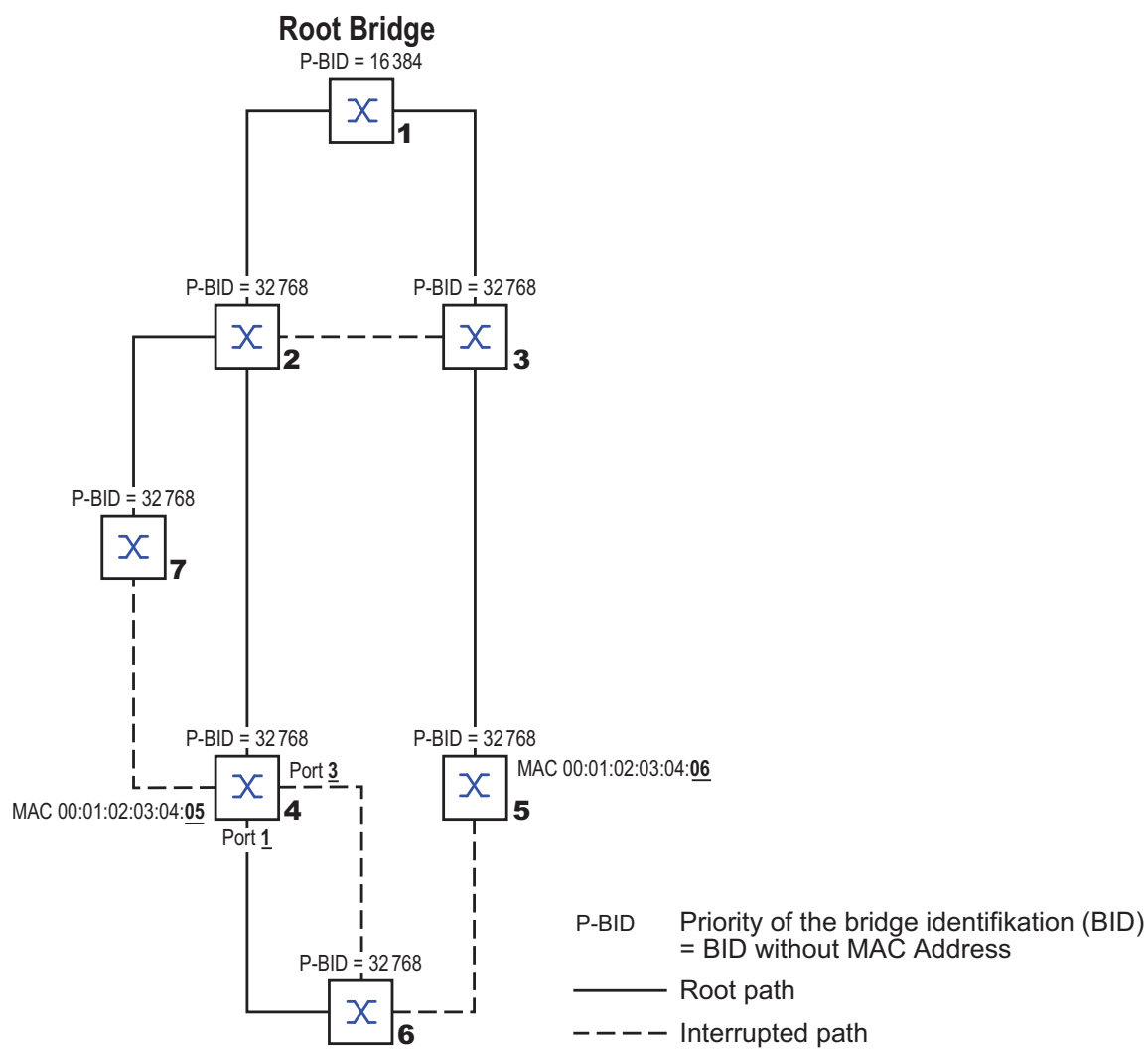

Figure 47: Example of determining the root path

6.4 Example of manipulating the root path

You can use the network plan (see figure 47) to follow the flow chart (see figure 46) for determining the root path. The Administrator has performed the following:

- Left the default value of 32,768 (8000H) for every bridge apart from bridge 1 and bridge 5, and
- assigned to bridge 1 the value 16,384 (4000H), thus making it the root bridge.

The protocol blocks the path between bridge 2 and bridge 3 as a connection from bridge 3 via bridge 2 to the root bridge would mean higher path costs.

The path from bridge 6 to the root bridge is interesting:

- ▶ The path via bridge 5 and bridge 3 creates the same root path costs as the path via bridge 4 and bridge 2.
- ▶ STP selects the path using the bridge that has the lowest MAC address in the bridge identification (bridge 4 in the illustration).
- ▶ There are also 2 paths between bridge 6 and bridge 4. The port identifier is decisive here.

Note: Because the Administrator does not change the default values for the priorities of the bridges in the bridge identifier, apart from the value for the root bridge, the MAC address in the bridge identifier alone determines which bridge becomes the new root bridge if the current root bridge goes down.

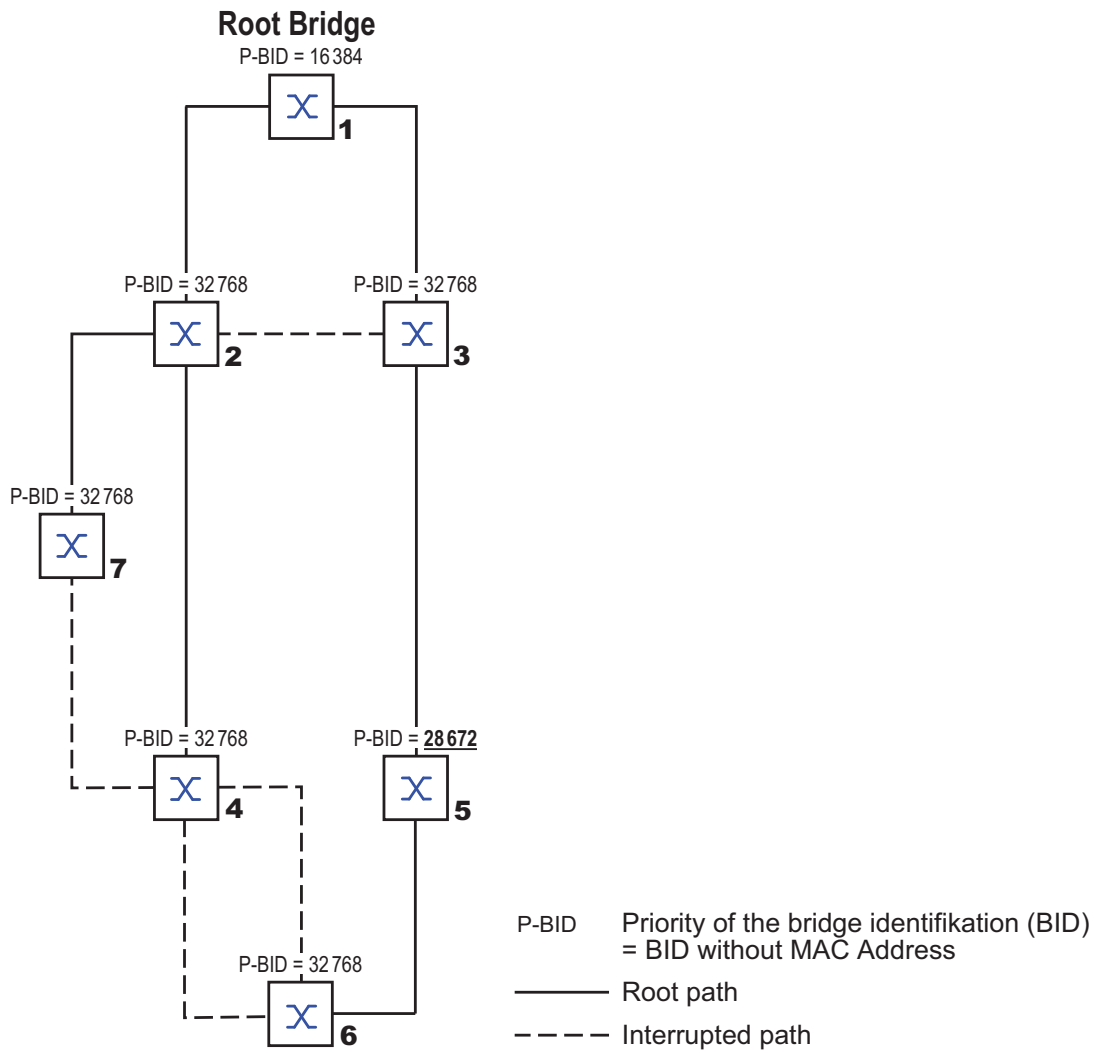

Figure 48: Example of manipulating the root path

6.5 Example of manipulating the tree structure

The Management Administrator soon discovers that this configuration with bridge 1 as the root bridge (see on page 97 “Example of determining the root path”) is invalid. On the paths from bridge 1 to bridge 2 and bridge 1 to bridge 3, the control packets which the root bridge sends to all other bridges add up. If the Management Administrator configures bridge 2 as the root bridge, the burden of the control packets on the subnetworks is distributed much more evenly. The result is the configuration shown here (see figure 49). The path costs for most of the bridges to the root bridge have decreased.

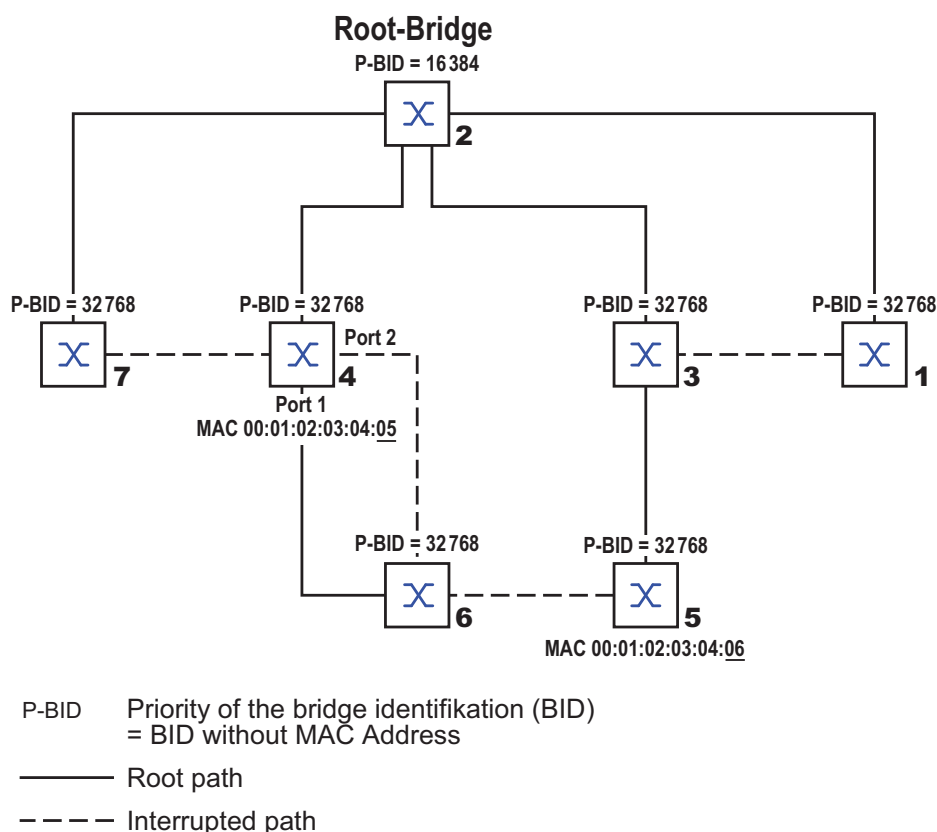

Figure 49: Example of manipulating the tree structure

6.6 The Rapid Spanning Tree Protocol

The RSTP uses the same algorithm for determining the tree structure as STP. RSTP merely changes parameters, and adds new parameters and mechanisms that speed up the reconfiguration if a link or bridge becomes inoperable.

The ports play a significant role in this context.

6.6.1 Port roles

RSTP assigns each bridge port one of the following roles ([see figure 50](#)):

► **Root Port:**

This is the port at which a bridge receives data packets with the lowest path costs from the root bridge.

If there are multiple ports with equally low path costs, the bridge ID of the bridge that leads to the root (designated bridge) decides which of its ports is given the role of the root port by the bridge further away from the root. If a bridge has multiple ports with equally low path costs to the same bridge, the bridge uses the port ID of the bridge leading to the root (designated bridge) to decide which port it selects locally as the root port ([see figure 46](#)).

The root bridge itself does not have a root port.

► **Designated port:**

The bridge in a network segment that has the lowest root path costs is the designated bridge.

If more than 1 bridge has the same root path costs, the bridge with the smallest value bridge identifier becomes the designated bridge. The designated port on this bridge is the port that connects a network segment leading away from the root bridge. If a bridge is connected to a network segment with more than one port (via a hub, for example), the bridge gives the role of the designated port to the port with the better port ID.

- ▶ **Edge port**
Every network segment with no additional RSTP bridges is connected with exactly one designated port. In this case, this designated port is also an edge port. The distinction of an edge port is the fact that it does not receive any RST BPDUs (Rapid Spanning Tree Bridge Protocol Data Units).
- ▶ **Alternate port**
This is a blocked port that takes over the task of the root port if the connection to the root bridge is lost. The alternate port provides a backup connection to the root bridge.
- ▶ **Backup port**
This is a blocked port that serves as a backup in case the connection to the designated port of this network segment (without any RSTP bridges) is lost
- ▶ **Disabled port**
This is a port that does not participate in the Spanning Tree Operation, i.e., the port is switched off or does not have any connection.

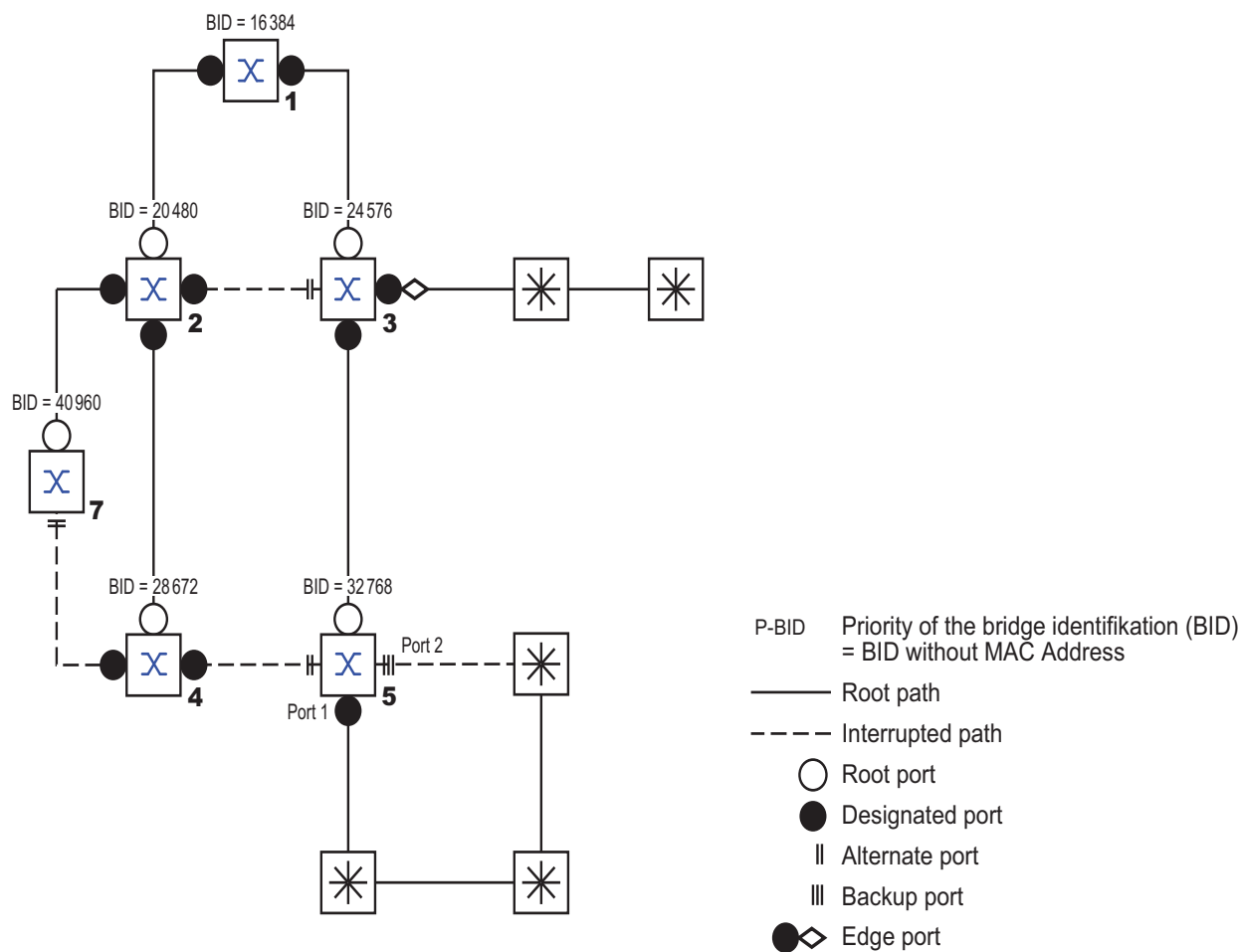

Figure 50: Port role assignment

6.6.2 Port states

Depending on the tree structure and the state of the selected connection paths, the RSTP assigns the ports their states.

STP port state	Administrative bridge port state	MAC operational	RSTP Port state	Active topology (port role)
DISABLED	Disabled	FALSE	Discarding ^a	Excluded (disabled)
DISABLED	Enabled	FALSE	Discarding ^a	Excluded (disabled)
BLOCKING	Enabled	TRUE	Discarding ^b	Excluded (alternate, backup)
LISTENING	Enabled	TRUE	Discarding ^b	Included (root, designated)
LEARNING	Enabled	TRUE	Learning	Included (root, designated)
FORWARDING	Enabled	TRUE	Forwarding	Included (root, designated)

Table 14: Relationship between port state values for STP and RSTP.

- a. The dot1d-MIB displays "Disabled"
- b. The dot1d-MIB displays "Blocked"

Meaning of the RSTP port states:

- ▶ Disabled: Port does not belong to the active topology
- ▶ Discarding: No address learning in FDB, no data traffic except for STP BPDUs
- ▶ Learning: Address learning active (FDB) and no data traffic except for STP BPDUs
- ▶ Forwarding: Address learning is active (FDB), sending and receipt of all frame types (not only STP BPDUs)

6.6.3 Spanning Tree Priority Vector

To assign roles to the ports, the RSTP bridges exchange configuration information with each other. This information is known as the Spanning Tree Priority Vector. It is part of the RSTP BPDUs and contains the following information:

- ▶ Bridge identification of the root bridge
- ▶ Root path costs of the sending bridge
- ▶ Bridge identification of the sending bridge
- ▶ Port identifiers of the ports through which the message was sent
- ▶ Port identifiers of the ports through which the message was received

Based on this information, the bridges participating in RSTP are able to determine port roles themselves and define the port states of their own ports.

6.6.4 Fast reconfiguration

Why can RSTP react faster than STP to an interruption of the root path?

- ▶ Introduction of edge-ports:
During a reconfiguration, RSTP switches an edge port into the transmission mode after three seconds and then waits for the “Hello Time” (see table 15) to elapse, to be sure that no bridge sending BPDUs is connected.
When the user determines that a terminal device is connected at this port and will remain connected, he can switch off RSTP at this port. Thus no waiting times occur at this port in the case of a reconfiguration.
- ▶ Introduction of alternate ports:
As the port roles are already distributed in normal operation, a bridge can immediately switch from the root port to the alternative port after the connection to the root bridge is lost.
- ▶ Communication with neighboring bridges (point-to-point connections):
Decentralized, direct communication between neighboring bridges enables reaction without wait periods to status changes in the spanning tree topology.

- ▶ **Address table:**
With STP, the age of the entries in the FDB determines the updating of communication. RSTP immediately deletes the entries in those ports affected by a reconfiguration.
- ▶ **Reaction to events:**
Without having to adhere to any time specifications, RSTP immediately reacts to events such as connection interruptions, connection reinstatements, etc.

Note: The downside of this fast reconfiguration is the possibility that data packages could be duplicated and/or arrive at the recipient in the wrong order during the reconfiguration phase of the RSTP topology. If this is unacceptable for your application, use the slower Spanning Tree Protocol or select one of the other, faster redundancy procedures described in this manual.

6.6.5 Configuring the Rapid Spanning Tree

- Set up the network to meet your demands.

Note: Before you connect the redundant lines, you must complete the configuration of the RSTP.

You thus avoid loops during the configuration phase.

- For devices with DIP switches, you switch these to “deactivated” (both to ON), so that the software configuration is not restricted.
- Select the `Redundancy:Rapid Spanning Tree:Global` dialog.
- Switch on RSTP on each device

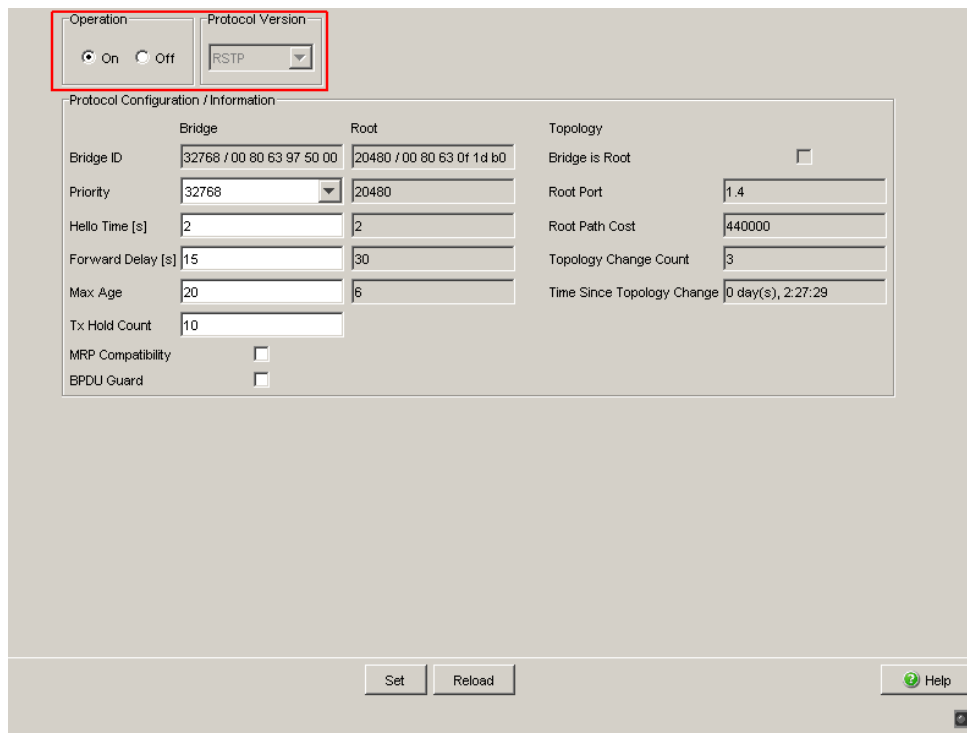

Figure 51: Operation on/off

- Define the desired Switch as the root bridge by assigning it the lowest priority in the bridge information among all the bridges in the network, in the “Protocol Configuration/Information” frame. Note that only multiples of 4,096 can be entered for this value (see table 15). In the “Root Information” frame, the dialog shows this device as the root.
A root switch has no root port and a root cost of 0.
- If necessary, change the default priority value of 32,768 in other bridges in the network in the same way to the value you want (multiples of 4,096).
For each of these bridges, check the display in the “Root Information” frame:
 - Root-ID: Displays the root bridge’s bridge identifier
 - Root Port: Displays the port leading to the root bridge
 - Root Cost: Displays the root cost to the root bridge
 in the “Protocol Configuration/Information” frame:
 - Priority: Displays the priority in the bridge identifier for this bridge
 - MAC Address: Displays the MAC address of this Switch
 - Topology Changes: Displays the number of changes since the start of RSTP
 - Time since last change: Displays the time that has elapsed since the last network reconfiguration

- If necessary, change the values for “Hello Time”, “Forward Delay” and “Max. Age” on the rootbridge. The root bridge then transfers this data to the other bridges. The dialog displays the data received from the root bridge in the left column. In the right column you enter the values which shall apply when this bridge becomes the root bridge. For the configuration, take note of [table 15](#).

Protocol Configuration / Information		
Bridge	Root	
Bridge ID	32768 / 00 80 63 97 50 00	20480 / 00 80 63 0f 1d b0
Priority	32768	20480
Hello Time [s]	2	2
Forward Delay [s]	15	30
Max. Age	20	16
Tx Hold Count	10	
MRP Compatibility	<input type="checkbox"/>	
BPDU Guard	<input type="checkbox"/>	

Topology	
Bridge is Root	<input type="checkbox"/>
Root Port	1.4
Root Path Cost	440000
Topology Change Count	3
Time Since Topology Change	0 day(s), 2:27:29

Figure 52: Assigning Hello Time, Forward Delay and Max. Age

The times entered in the RSTP dialog are in units of 1 s
 Example: a Hello Time of 2 corresponds to 2 seconds.

- Now connect the redundant lines.

Parameter	Meaning	Possible Values	Default Setting
Priority	The priority and the MAC address go together to make up the bridge identification.	$0 < n * 4,096 (1000H) < 61,440 (F000H)$	32,768 (8000H)
Hello Time	Sets the Hello Time. The local Hello Time is the time in seconds between the sending of two configuration messages (Hello packets). If the local device has the root function, the other devices in the entire network take over this value. Otherwise the local device uses the value of the root bridge in the "Root" column on the right.	1 - 2	2
Forward Delay	Sets the Forward Delay parameter. In the previous STP protocol, the Forward Delay parameter was used to delay the status change between the statuses disabled, discarding, learning, forwarding. Since the introduction of RSTP, this parameter has a subordinate role, because the RSTP bridges negotiate the status change without any specified delay. If the local device is the root, the other devices in the entire network take over this value. Otherwise the local device uses the value of the root bridge in the "Root" column on the right.	4 - 30 s See the note following this table.	15 s
Max Age	Sets the Max Age parameter. In the previous STP protocol, the Max Age parameter was used to specify the validity of STP BPDUs in seconds. For RSTP, Max Age signifies the maximum permissible branch length (number of devices to the root bridge). If the local device is the root, the other devices in the entire network take over this value. Otherwise the local device uses the value of the root bridge in the "Root" column on the right.	6 - 40 s See the note following this table.	20 s

Table 15: Global RSTP settings

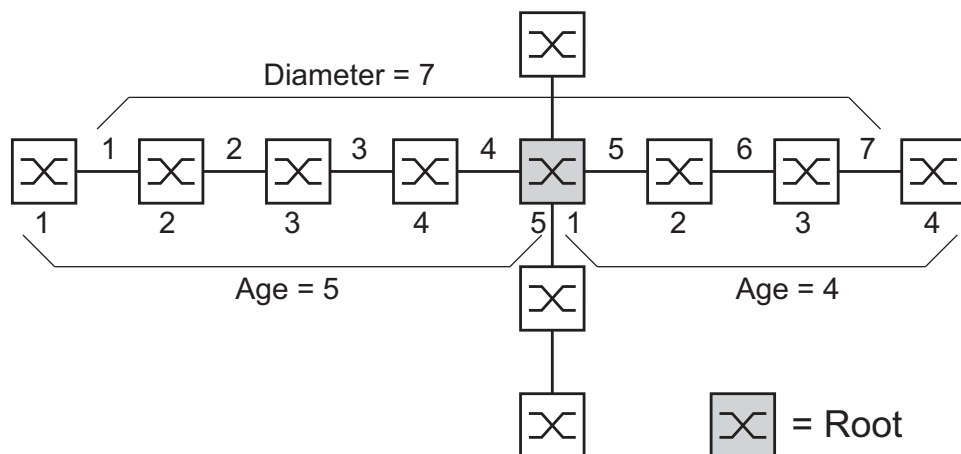

Figure 53: Definition of diameter and age

The network diameter is the number of connections between the two devices furthest away from the root bridge.

Note: The parameters

- Forward Delay and
- Max Age

have a relationship to each other:

Forward Delay \geq (Max Age/2) + 1

If you enter values that contradict this relationship, the device then replaces these values with a default value or with the last valid values.

- When necessary, change and verify the settings and displays that relate to each individual port (dialog: Rapid Spanning Tree:Port).

Module	Port	STP State Enable	Port State	Priority	Port Pathcost	Admin EdgePort	Oper EdgePort	Auto EdgePort	Oper PointToPoint	Designated Root (Priority/MAC Adres)
1	1	<input checked="" type="checkbox"/>	disabled	128	0	false	false	true	false	80 00 00 80 63 74 67
1	2	<input checked="" type="checkbox"/>	disabled	128	0	false	false	true	false	80 00 00 80 63 74 67
1	3	<input checked="" type="checkbox"/>	disabled	128	0	false	false	true	false	80 00 00 80 63 74 67
1	4	<input checked="" type="checkbox"/>	disabled	128	0	false	false	true	false	80 00 00 80 63 74 67
1	5	<input checked="" type="checkbox"/>	disabled	128	0	false	false	true	false	80 00 00 80 63 74 67
1	6	<input checked="" type="checkbox"/>	disabled	128	0	false	false	true	false	80 00 00 80 63 74 67
1	7	<input checked="" type="checkbox"/>	disabled	128	0	false	false	true	false	80 00 00 80 63 74 67
1	8	<input checked="" type="checkbox"/>	disabled	128	0	false	false	true	false	80 00 00 80 63 74 67
1	9	<input checked="" type="checkbox"/>	manualFwd	128	0	false	false	true	true	80 00 00 80 63 74 67
1	10	<input checked="" type="checkbox"/>	disabled	128	0	false	false	true	false	80 00 00 80 63 74 67
1	11	<input checked="" type="checkbox"/>	disabled	128	0	false	false	true	false	80 00 00 80 63 74 67
1	12	<input checked="" type="checkbox"/>	disabled	128	0	false	false	true	false	80 00 00 80 63 74 67
1	13	<input checked="" type="checkbox"/>	disabled	128	0	false	false	true	false	80 00 00 80 63 74 67
1	14	<input checked="" type="checkbox"/>	disabled	128	0	false	false	true	false	80 00 00 80 63 74 67
1	15	<input checked="" type="checkbox"/>	disabled	128	0	false	false	true	false	80 00 00 80 63 74 67
1	16	<input checked="" type="checkbox"/>	disabled	128	0	false	false	true	false	80 00 00 80 63 74 67
1	17	<input checked="" type="checkbox"/>	disabled	128	0	false	false	true	false	80 00 00 80 63 74 67
1	18	<input checked="" type="checkbox"/>	disabled	128	0	false	false	true	false	80 00 00 80 63 74 67
1	19	<input checked="" type="checkbox"/>	disabled	128	0	false	false	true	false	80 00 00 80 63 74 67
1	20	<input checked="" type="checkbox"/>	disabled	128	0	false	false	true	false	80 00 00 80 63 74 67
1	21	<input checked="" type="checkbox"/>	disabled	128	0	false	false	true	false	80 00 00 80 63 74 67
1	22	<input checked="" type="checkbox"/>	disabled	128	0	false	false	true	false	80 00 00 80 63 74 67

Set Reload Help

Figure 54: Configuring RSTP for each port

Note: Deactivate the Spanning Tree Protocol on the ports connected to a redundant ring, because Spanning Tree and Ring Redundancy work with different reaction times.

If you are using the device in a Multiple Spanning Tree (MSTP) environment, the device only participates in the Common Spanning Tree (CST) instance. This chapter of the manual also uses the term Global MST instance to describe this general case.

Parameter	Meaning	Possible Values	Default Setting
STP active	Here you can switch Spanning Tree on or off for this port. If Spanning Tree is activated globally and switched off at one port, this port does not send STP-BPDUs and drops any STP-BPDUs received.	On, Off	On
<p>Note: If you want to use other layer 2 redundancy protocols such as HIPER-Ring or Ring/Network coupling in parallel with Spanning Tree, make sure you switch off the ports participating in these protocols in this dialog for Spanning Tree. Otherwise the redundancy may not operate as intended or loops can result.</p>			
Port status (read only)	Displays the STP port status with regard to the global MSTI (IST).	discarding, learning, forwarding, disabled, manualForwarding, notParticipate	-
Port priority	Here you enter the port priority (the four highest bits of the port ID) with regard to the global MSTI (IST) as a decimal number of the highest byte of the port ID.	$16 \leq n \cdot 16 \leq 240$	128
Port path costs	Enter the path costs with regard to the global MSTI (IST) to indicate preference for redundant paths. If the value is 0, the Switch automatically calculates the path costs for the global MSTI (IST) depending on the transmission rate.	0 - 200,000,000	0 (automatically)

Table 16: Port-related RSTP settings and displays

Parameter	Meaning	Possible Values	Default Setting
Admin Edge Port	<p>Only activate this setting when a terminal device is connected to the port (administrative: default setting). Then the port immediately has the forwarding status after a link is set up, without first going through the STP statuses. If the port still receives an STP-BPDU, the device blocks the port and clarifies its STP port role. In the process, the port can switch to a different status, e.g. forwarding, discarding, learning.</p> <p>Deactivate the setting when the port is connected to a bridge. After a link is set up, the port then goes through the STP statuses first before taking on the <code>forwarding</code> status, if applicable.</p> <p>This setting applies to all MSTIs.</p>	<code>active</code> (box selected), <code>inactive</code> (box empty)	<code>inactive</code>
Oper Edge Port (read only)	<p>The device sets the “Oper Edge Port” condition to <code>true</code> if it has not received any STP-BPDUs, i.e. a terminal device is connected. It sets the condition to <code>false</code> if it has received STP-BPDUs, i.e. a bridge is connected.</p> <p>This condition applies to all MSTIs.</p>	<code>true</code> , <code>false</code>	-
Auto Edge Port	<p>The device only considers the Auto Edge Port setting when the Admin Edge Port parameter is deactivated. If Auto Edge Port is active, after a link is set up the device sets the port to the forwarding status after $1.5 \cdot \text{Hello Time}$ (in the default setting 3 s).</p> <p>If Auto Edge Port is deactivated, the device waits for the <code>Max Age</code> instead (in the default setting 20 s).</p> <p>This setting applies to all MSTIs.</p>	<code>active</code> (box selected), <code>inactive</code> (box empty)	<code>active</code>

Table 16: Port-related RSTP settings and displays

Parameter	Meaning	Possible Values	Default Setting
Oper Point-to-Point (read only)	The device sets the “Oper point-to-point” condition to <code>true</code> if this port has a full duplex condition to an STP device. Otherwise it sets the condition to <code>false</code> (e.g. if a hub is connected). The point-to-point connection makes a direct connection between 2 RSTP devices. The direct, decentralized communication between the two bridges results in a short reconfiguration time. This condition applies to all MSTIs.	<code>true, false</code> The device determines this condition from the duplex mode: FDX: <code>true</code> HDX: <code>false</code>	
Received bridge ID (read only)	Displays the remote bridge ID from which this port last received an STP-BPDU. ^a	Bridge identification (format ppppp / mm mm mm mm mm mm)	-
Received path costs (read only)	Displays the path costs of the remote bridge from its root port to the CIST root bridge. ^a	0-200,000,000	-
Received port ID (read only)	Displays the port ID at the remote bridge from which this port last received an STP-BPDU. ^a	Port ID, format pn nn, with p: port priority / 16, nnn: port No., (both hexadecimal)	-

Table 16: Port-related RSTP settings and displays

- ^a These columns show you more detailed information than that available up to now:
For designated ports, the device displays the information for the STP-BPDU last received by the port. This helps with the diagnosis of possible STP problems in the network.
For the port roles alternative, back-up, master and root, in the stationary condition (static topology), this information is identically to the designated information.
If a port has no link, or if it has not received any STP-BDPUs for the current MSTI, the device displays the values that the port would send as a designated port.

6.7 Combining RSTP and MRP

In the MRP compatibility mode, the device allows you to combine RSTP with MRP.

With the combination of RSTP and MRP, the fast switching times of MRP are maintained.

The RSTP diameter (see figure 53) depends on the “Max Age”. It applies to the devices outside the MRP-Ring.

Note: The combination of RSTP and MRP presumes that both the root bridge and the backup root bridge are located within the MRP-Ring.

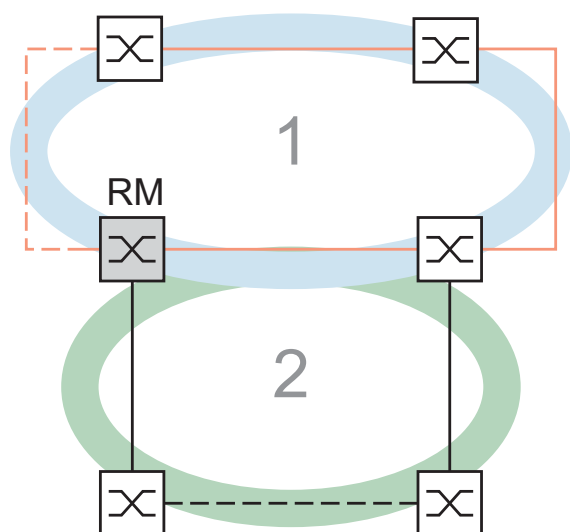

Figure 55: Combination of RSTP and MRP

1: MRP-Ring

2: RSTP-Ring

RM: Ring Manager

To combine RSTP with MRP, you perform the following steps in sequence:

- ▶ Configure MRP on all devices in the MRP-Ring.
- ▶ Close the redundant line in the MRP-Ring.
- ▶ Activate RSTP at the RSTP ports and also at the MRP-Ring ports.
- ▶ Configure the RSTP root bridge and the RSTP backup root bridge in the MRP-Ring:
 - Set their priority.
 - If you exceed the RSTP diameter specified by the preset value of $\text{Max Age} = 20$, modify Max Age and Forward Delay accordingly.
- ▶ Switch on RSTP globally.
- ▶ Switch on the MRP compatibility mode.
- ▶ After configuring all the participating devices, connect the redundant RSTP connection.

6.7.1 Application example for the combination of RSTP and MRP

The figure (see figure 56) shows an example for the combination of RSTP and MRP.

Parameters	S1	S2	S3	S4	S5	S6
MRP settings						
Ring redundancy: MRP version	MRP	MRP			MRP	MRP
Ring port 1	1.1	1.1			1.1	1.1
Ring port 2	1.2	1.2			1.2	1.2
Port from MRP-Ring to the RSTP network	1.3	1.3	-	-	-	-
Redundancy Manager mode	On	Off	-	-	Off	Off
MRP operation	On	On	Off	Off	On	On
RSTP settings						
For each RSTP port: STP State Enable	On	On	On	On	On	On
Protocol Configuration: priority (S2<S1<S3 and S2<S1<S4)	4,096	0	32,768	32,768	32,768	32,768
RSTP:Global: Operation	On	On	On	On	On	On
RSTP:Global: MRP compatibility	On	On	-	-	On	On

Table 17: Values for the configuration of the switches of the MRP/RSTP example

Prerequisites for further configuration:

- ▶ You have configured the MRP settings for the devices in accordance with the above table.
- ▶ The redundant line in the MRP-Ring is closed.

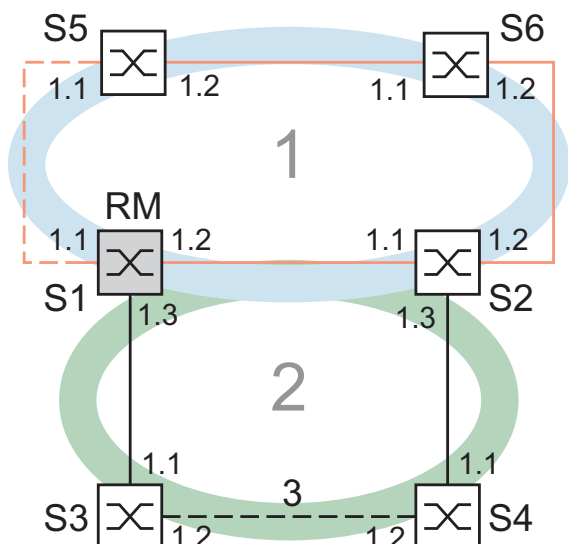

Figure 56: Application example for the combination of RSTP and MRP
 1: MRP-Ring, 2: RSTP-Ring, 3: Redundant RSTP connection
 RM: Ring Manager
 S2 is RSTP Root Bridge
 S1 is RSTP Backup Root Bridge

- Activate RSTP at the ports, using S1 as an example ([see table 17](#)).

```
enable
configure
interface 1/1

spanning-tree port mode
exit
interface 1/2

spanning-tree port mode
```

Switch to the privileged EXEC mode.
 Switch to the Configuration mode.
 Switch to the Interface Configuration mode of interface 1/1.
 Activate RSTP on the port.
 Switch to the Configuration mode.
 Switch to the interface configuration mode for port 1.2.
 Activate RSTP on the port.

<pre>exit</pre>	Switch to the Configuration mode.
<pre>interface 1/3</pre>	Switch to the interface configuration mode for port 1.3.
<pre>spanning-tree port mode</pre>	Activate RSTP on the port.
<pre>exit</pre>	Switch to the Configuration mode.

- Configure the global settings, using S1 as an example:
 - the RSTP priority
 - global operation
 - the MRP compatibility mode

<pre>spanning-tree mst priority 0 4096</pre>	Set the RSTP priority for the MST instance 0 to the value 4,096. the MST instance 0 is the default instance.
<pre>spanning-tree</pre>	Activate RSTP operation globally.
<pre>spanning-tree stp-mrp-mode</pre>	Activate MRP compatibility.

- Configure the other switches S2 though S6 with their respective values ([see table 17](#)).
- Connect the redundant RSTP connection.

A Readers' Comments

What is your opinion of this manual? We are always striving to provide as comprehensive a description of our product as possible, as well as important information that will ensure trouble-free operation. Your comments and suggestions help us to further improve the quality of our documentation.

Your assessment of this manual:

	Very good	Good	Satisfactory	Mediocre	Poor
Precise description	<input type="radio"/>	<input type="radio"/>	<input type="radio"/>	<input type="radio"/>	<input type="radio"/>
Readability	<input type="radio"/>	<input type="radio"/>	<input type="radio"/>	<input type="radio"/>	<input type="radio"/>
Understandability	<input type="radio"/>	<input type="radio"/>	<input type="radio"/>	<input type="radio"/>	<input type="radio"/>
Examples	<input type="radio"/>	<input type="radio"/>	<input type="radio"/>	<input type="radio"/>	<input type="radio"/>
Structure	<input type="radio"/>	<input type="radio"/>	<input type="radio"/>	<input type="radio"/>	<input type="radio"/>
Completeness	<input type="radio"/>	<input type="radio"/>	<input type="radio"/>	<input type="radio"/>	<input type="radio"/>
Graphics	<input type="radio"/>	<input type="radio"/>	<input type="radio"/>	<input type="radio"/>	<input type="radio"/>
Drawings	<input type="radio"/>	<input type="radio"/>	<input type="radio"/>	<input type="radio"/>	<input type="radio"/>
Tables	<input type="radio"/>	<input type="radio"/>	<input type="radio"/>	<input type="radio"/>	<input type="radio"/>

Did you discover any errors in this manual?
If so, on what page?

Readers' Comments

Suggestions for improvement and additional information:

General comments:

Sender:

Company / Department:

Name / Telephone no.:

Street:

Zip code / City:

e-mail:

Date / Signature:

Dear User,

Please fill out and return this page

- ▶ as a fax to the number +49 (0)7127 14-1600 or
- ▶ by post to

Hirschmann Automation and Control GmbH
Department 01RD-NT
Stuttgarter Str. 45-51
72654 Neckartenzlingen

B Index

A		N	
Advanced Mode	34	Network load	87, 89
Age	111	P	
Alternate port	103	PROFINET IO	5
B		Path costs	91, 94
BPDU	94	Port Identifier	90, 93
Backup port	103	Port number	93
Bridge Identifier	90	Port priority (Spanning Tree)	93
Bridge Protocol Data Unit	94	Port roles (RSTP)	102
C		Port-State	105
Configuration error	33, 37, 43	R	
Configuring the HIPER-Ring	29, 41	RM function	25
D		RST BPDU	103, 106
DIP-switch	29	RSTP	9
Designated bridge	102	Rapid Spanning Tree	9, 102
Designated port	102	Reconfiguration	89
Diameter	111	Redundancy	5
Disabled port	103	Redundancy Manager	27
E		Redundancy existing	33, 37, 43
Edge port	103	Redundancy functions	9
F		Redundant Coupling	9, 12, 21
FAQ	125	Redundant connections	87
Fast HIPER-Ring (port VLAN ID)	9	Redundant coupling	9
Forward Delay	110	Ring	25
H		Ring Manager	27
HIPER-Ring	9, 12, 22	Ring Redundancy	10, 10, 10
Hello Time	110	Ring manager	25
I		Ring structure	26
Industrial HiVision	6	Ring/Network coupling	9
Industry Protocols	5	Root Bridge	94
L		Root Path Cost	90
LACP Link Aggregation Control Protocol	15	Root path	97, 99
Link Aggregation	9, 12, 15, 22	Root port	102
Loops	74, 76, 82, 84	S	
M		STP-BPDU	94
Max Age	110	Sub-Ring	9, 46
		Symbol	7
		T	
		Technical Questions	125
		Training Courses	125
		Tree structure (Spanning Tree)	94, 101
		Trunk	15

V	
VLAN (settings for HIPER-Ring)	32

C Further Support

■ Technical Questions

For technical questions, please contact any Hirschmann dealer in your area or Hirschmann directly.

You will find the addresses of our partners on the Internet at <http://www.hirschmann.com>

Contact our support at <https://hirschmann-support.belden.eu.com>

You can contact us

in the EMEA region at

- ▶ Tel.: +49 (0)1805 14-1538
- ▶ E-mail: hac.support@belden.com

in the America region at

- ▶ Tel.: +1 (717) 217-2270
- ▶ E-mail: inet-support.us@belden.com

in the Asia-Pacific region at

- ▶ Tel.: +65 6854 9860
- ▶ E-mail: inet-ap@belden.com

■ Hirschmann Competence Center

The Hirschmann Competence Center is ahead of its competitors:

- ▶ Consulting incorporates comprehensive technical advice, from system evaluation through network planning to project planning.
- ▶ Training offers you an introduction to the basics, product briefing and user training with certification.

The current technology and product training courses can be found at <http://www.hicomcenter.com>

- ▶ Support ranges from the first installation through the standby service to maintenance concepts.

With the Hirschmann Competence Center, you have decided against making any compromises. Our client-customized package leaves you free to choose the service components you want to use.

Internet:

<http://www.hicomcenter.com>



HIRSCHMANN

A **BELDEN** BRAND